

Hops Irrigation Best Practices in the Midwest Great Lakes Region



Chris Lattak
Engineering, Sales and Customer
Support – SW Michigan
chris@trickl-eez.com
4266 Hollywood Road
St. Joseph, MI 49085
269.429.8200 800.874.2553

GREAT LAKES HOP AND
BARLEY CONFERENCE

March 2-3, 2017 ~ Westin Book Cadillac Detroit

Chris Lattak
MSU 1999, JD 2002,
but continuously learning



Trickl-eez Irrigation

System design, sales, installation

- 11+ years, working primarily with new, smaller growers
- K-Line Pasture Irrigation
- Vinifera, Hops, Pome, Stone, Berries, some veggies
- Frost Protection
- Sub-surface Drip in field crops
- Focus on innovations in the industry - where is the industry going?



Nye Heritage Farms & Apple Barn, LLC - Co-owner, Farm Manager

- 110 acre fruit and vegetable farm in SW MI
- Nye's Apple Barn & Farm Market, St. Joseph, MI
- Returned to the farm in 2004 after unexpected passing of step-dad
- Juice grapes, apples, peaches, sweet cherries, pears, berries all manner of veggies, squash and pumpkins for the market

Trickl-eez Irrigation - Chris Lattak
(chris@trickl-eez.com)

Why Irrigate?

- Ability to apply water when, where, and in the amounts necessary to satisfy the needs of the hop plant
- Ability to most economically and efficiently apply nutrients; spoon feed
- More uniform, successful and rapid plant establishment and growth
- Significant yield increases of greater than 20% vs. unirrigated. (20% is considered a low number)
- Increase of Alpha acids vs. unirrigated

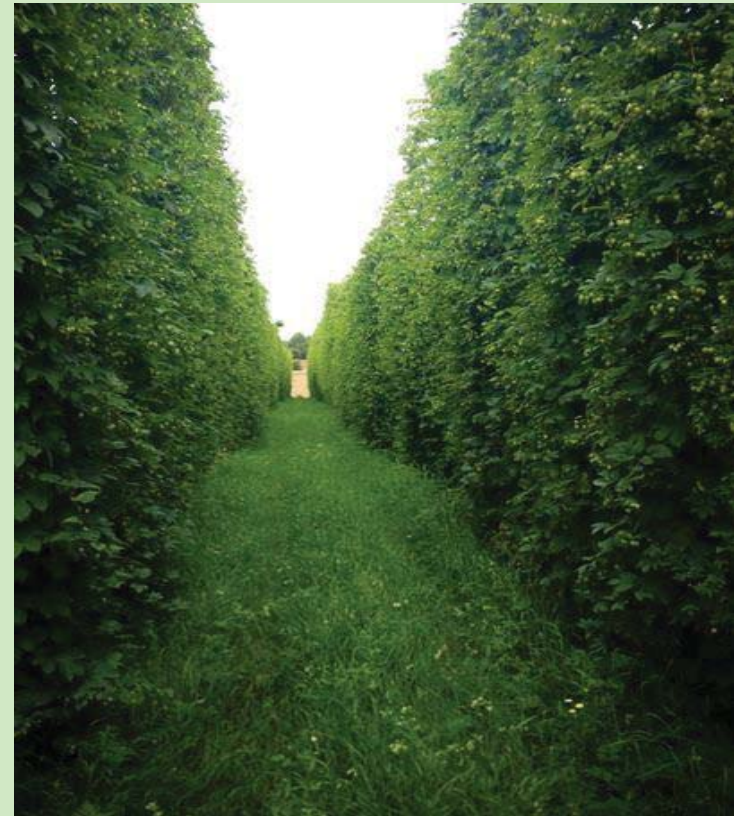

▲ Growth @ 12 months from planting



Trickl-eez Irrigation - Chris Lattak
(chris@trickl-eez.com)

Irrigation Options

* *Italics* are points that I have added

- **Dripper lines suspended** 14"- 18" above rows offer the advantages of easy inspection/maintenance; stay in place year-around; give a coir twine fastening point; and avoid damage from mechanical cultivation. Possible con: cannot cross cultivate hop yard (*or cross rows to hang coir twine*).
- **On the ground drip lines** can be rolled up each season; allow clump-style growing & cross cultivation. Possible cons: harder to inspect, no tie spot for coir twine; prone to more mechanical damage from cultivation; *shorter life span; greater animal or insect damage*.
- **Buried drip tape** – not recommended. Cannot inspect, often damaged during rhizome removal, not designed to match the longevity of a hop yard, *potential for roots to pinch off water delivery*.
- **Overhead sprinklers.** Overhead irrigation, or center pivot can be used successfully by growers who understand wet leaf diseases and time irrigation cycles to minimize wet leaf periods. Possible cons: has to be elevated to pole height; somewhat uneven distribution of water; (*very inefficient – 40% can be lost to wind and evaporation*); cannot be used effectively in windy weather, and is difficult to create different watering zones. Overhead sprinklers are best used in conjunction with drip irrigation to cool leaf temps on varieties susceptible to heat stress.



Trickl-eez Irrigation - Chris Lattak
(chris@trickl-eez.com)

From Great Lakes
Hops website with
italics added

Suspended or On Ground



Suspended



On Ground



Flatwater Farms



www.alamy.com - G2X6EG

Trickl-eez Irrigation - Chris Lattak
(chris@trickl-eez.com)

Suspended or On Ground Irrigation lines



Hanging Coir; Cross cultivating



Trickl-eez Irrigation - Chris Lattak
(chris@trickl-eez.com)

If replacing drip line with any regularity Heavy Wall Emitter Line (45mil) vs Thin Wall Emitter Line (20mil)

Assuming 14' row spacing - 3,100lf/acre; catalog pricing

- Heavy Wall Emitter Line (45mil)
- Normal 20+ year life span (above ground)
- Installed on the ground, moved multiple times (2-3?) per season for cultivation & removed for cross cultivation, and re-installed annually
- Replaced every 4 years
- $\$148/1,000' \times 3,100' = \$459/a$
- Thin Wall Emitter Line (35mil)
- Normal 10+ year life span (above ground)
- Installed on the ground, moved multiple times (2-3?) per season for cultivation & removed for cross cultivation, and re-installed annually
- Replaced every 4 years
- $\$100/1,000' \times 3,100' = \$310/a$

Are we applying too much water?



Trickl-eez Irrigation - Chris Lattak
(chris@trickl-eez.com)

Water and the Soil

- Soil Types
- Water movement in the soil?
- Water holding capacity of the soil?
- How much water do we need?

Soil Types, and Infiltration based on Texture



Infiltration Variations by Soil Texture

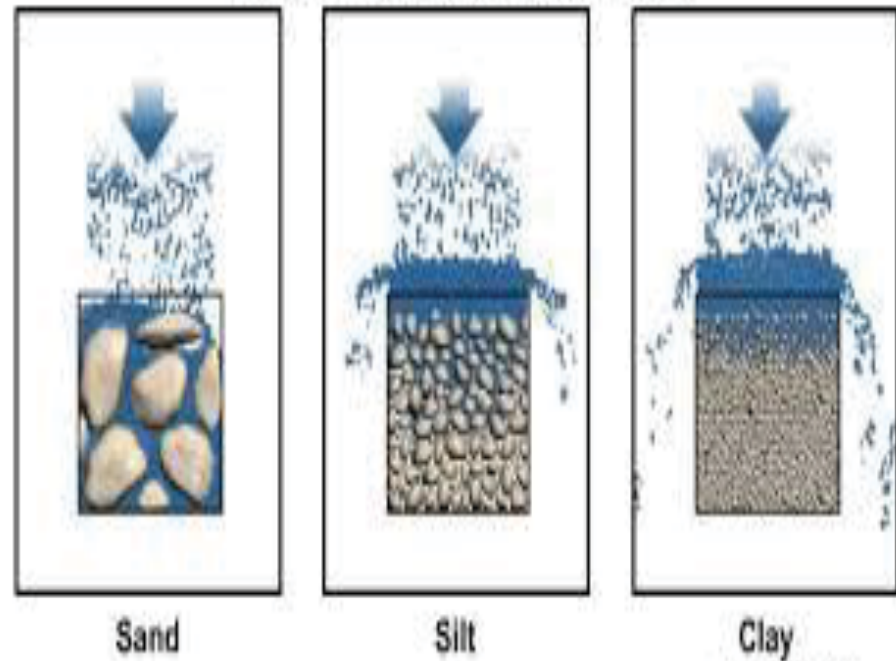

©The COMET Program

SOIL WATER

- **Leaching:** Movement of water and nutrients away from plant roots
- **Capillary water:** Held by the soil and available to plant through their roots
- **Gravitational water:** Moves down and away from the surface by gravity, not used by plant roots
- **Hygroscopic water:** Held so tightly by soil it is unavailable to plants

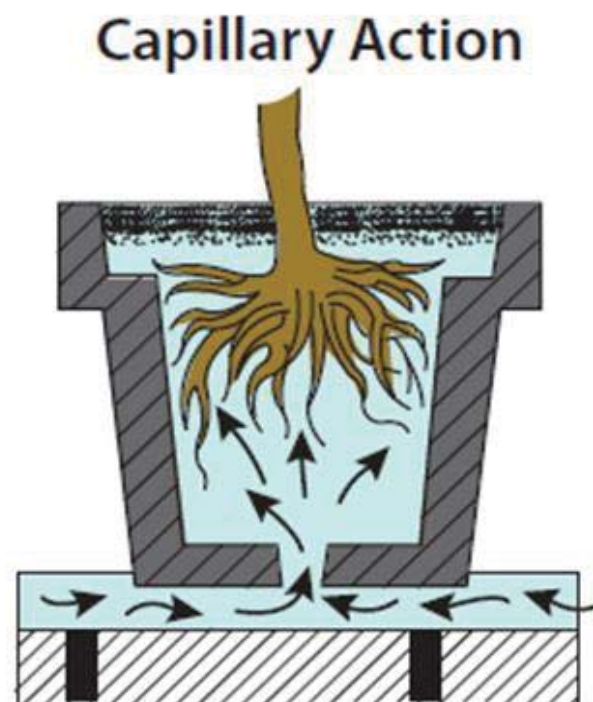

Capillary Action

- **Capillary action** (sometimes capillarity, **capillary** motion, or wicking) is the ability of a liquid to flow in narrow spaces without the assistance of, or even in opposition to, external forces like gravity.



How does water move in the soil?

SOIL TYPES



HEAVY CLAY

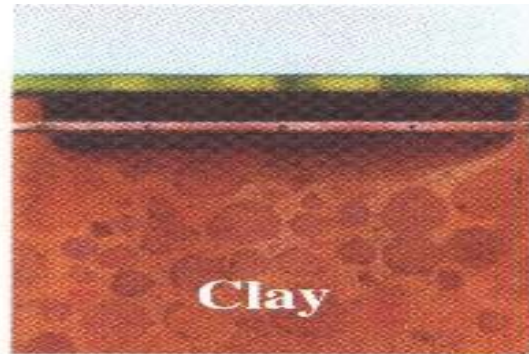

Clay



MEDIUM TEXTURED



Loam



LIGHT TEXTURED

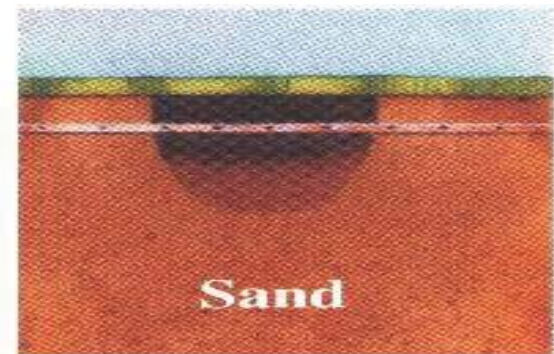

Sand

Movement of water in the soil

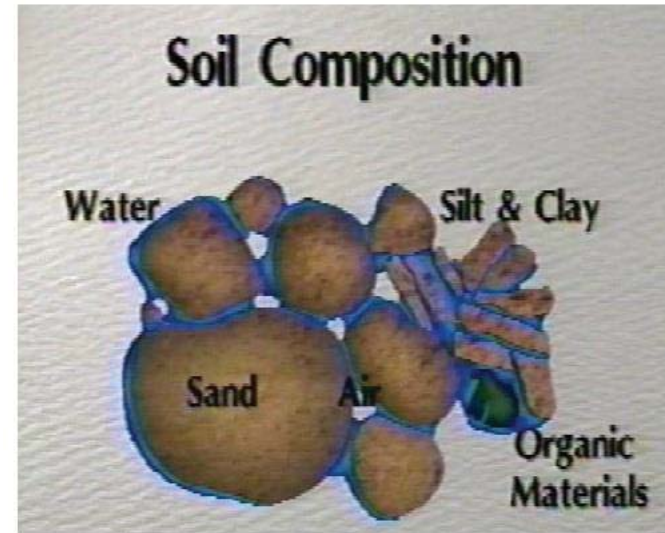
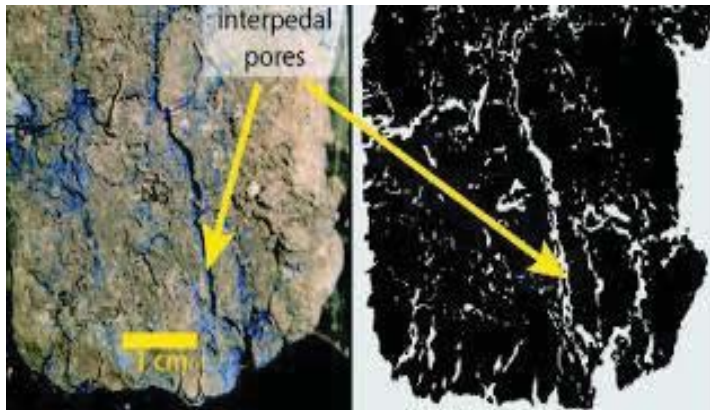

Trickl-eez Irrigation - Chris Lattak
(chris@trickl-eez.com)

Water movement across different soil types; Affect of compaction on soil

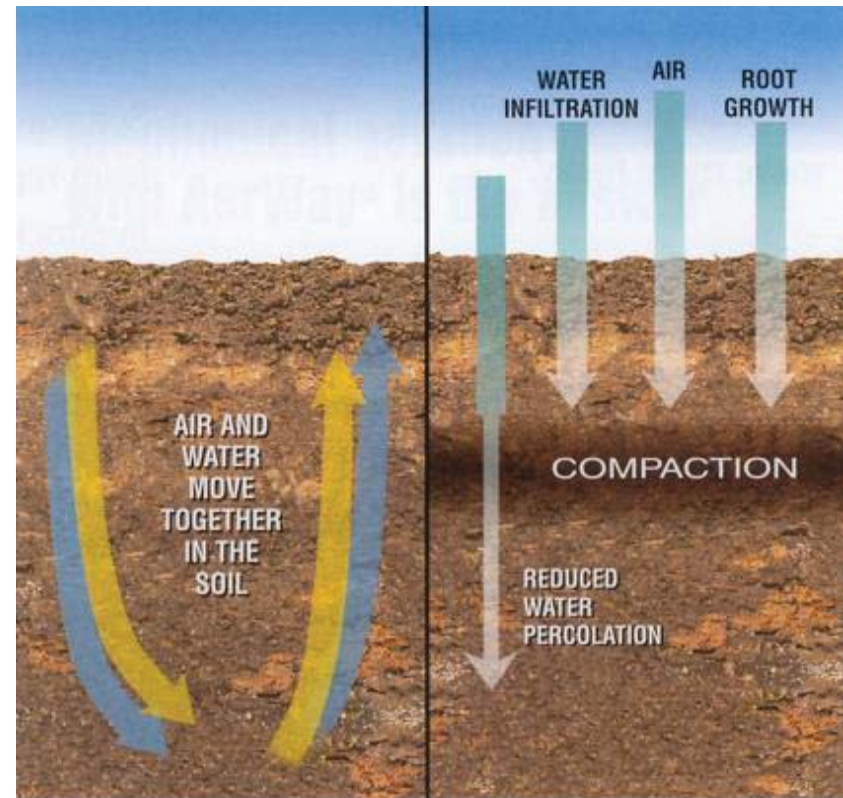
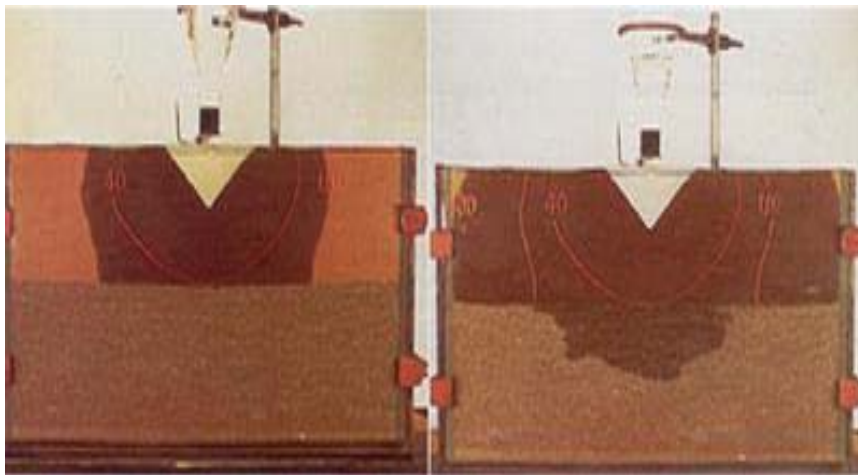
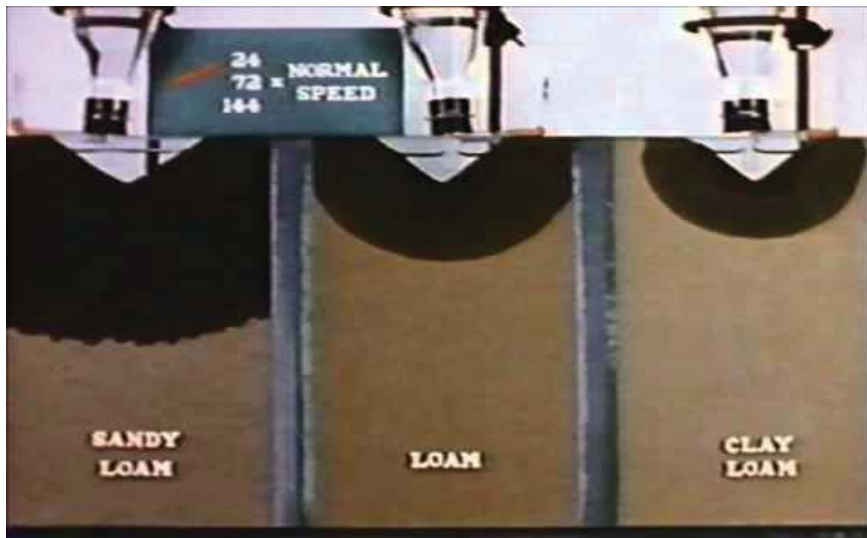

Trickl-eez Irrigation - Chris Lattak
(chris@trickl-eez.com)

Water Holding Capacity

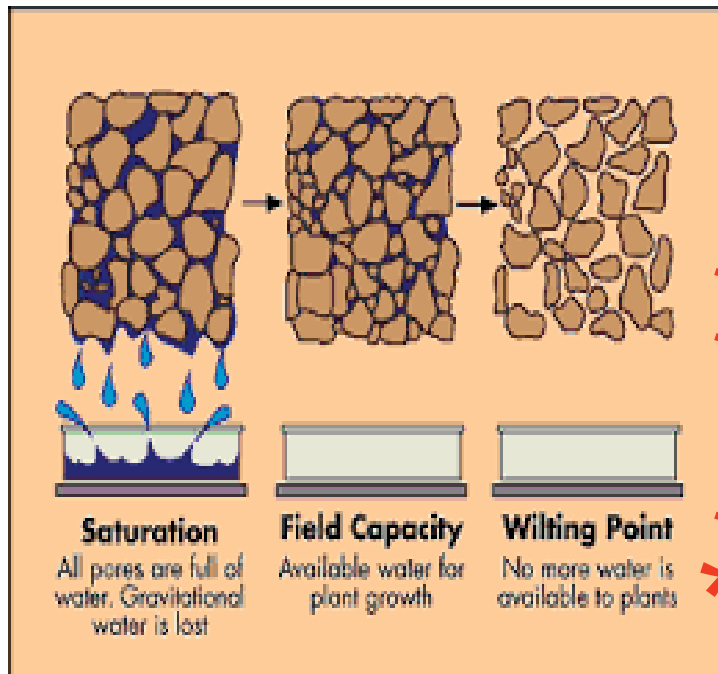

	~Inches of water/foot of soil~			Textural class	Water holding capacity, inches/foot of soil
	Sand	Loam	Silty clay loam		
Saturation	5.2	5.8	6.1	Coarse sand	0.25 - 0.75
* Field Capacity	2.1	3.8	4.4	Fine sand	0.75 - 1.00
* Permanent wilting point	1.1	1.8	2.6	Loamy sand	1.10 - 1.20
Oven dry	0	0	0	Sandy loam	1.25 - 1.40
Gravitational	3.1	2	1.7	Fine sandy loam	1.50 - 2.00
* Water holding capacity	1	2	1.8	Silt loam	2.00 - 2.50
* Plant available	0.5	1	0.9	Silty clay loam	1.80 - 2.00
Unavailable	1.1	1.8	2.6	Silty clay	1.50 - 1.70
				Clay	1.20 - 1.50

Saturation – all soil pores completely filled

Field Capacity – Saturated, allowed to drain 24-48 hours

Permanent Wilting Point – Point at which plant has extracted all the water that it can

Water Holding Capacity = Field Capacity – Permanent Wilting Point

* **Plant Available Water** – 50% of Water Holding Capacity

USDA Soil Web Survey

Area of Interest (AOI) **Soil Map** Soil Data Explorer Download Soils Data Shopping Cart (Free)

Printable Version Add to Shopping Cart

Search

Map Unit Legend

Berrien County, Michigan (MI021)

Map Unit Symbol	Map Unit Name	Acres in AOI	Percent of AOI
19A	Brady sandy loam, 0 to 2 percent slopes	56.5	83.2%
28B	Rimer loamy fine sand, 0 to 4 percent slopes	9.3	13.7%
34B	Blount loam, 0 to 4 percent slopes	2.1	3.2%
Totals for Area of Interest		68.0	100.0%

Soil Map

Legend

Scale (not to scale)

0 800 ft

Trickl-eez Irrigation - Chris Lattak
(chris@trickl-eez.com)

USDA Map Unit Description

Map Unit Description: Brady sandy loam, 0 to 2 percent slopes—Berrien County, Michigan

Berrien County, Michigan

19A—Brady sandy loam, 0 to 2 percent slopes

Map Unit Setting

National map unit symbol: 67q2
Elevation: 360 to 1,200 feet
Mean annual precipitation: 30 to 36 inches
Mean annual air temperature: 45 to 48 degrees F
Frost-free period: 140 to 150 days
Farmland classification: Prime farmland if drained

Map Unit Composition

Brady and similar soils: 91 percent
Minor components: 9 percent
Estimates are based on observations, descriptions, and transects of the mapunit.

Description of Brady

Setting

Landform: Outwash plains
Landform position (three-dimensional): Rise
Down-slope shape: Linear
Across-slope shape: Linear
Parent material: Loamy over sandy and gravelly outwash

Typical profile

H1 - 0 to 11 inches: sandy loam
H2 - 11 to 35 inches: sandy loam
H3 - 35 to 48 inches: loamy sand
H4 - 48 to 60 inches: sand

Properties and qualities

Slope: 0 to 2 percent
Depth to restrictive feature: More than 80 inches
Natural drainage class: Somewhat poorly drained
Runoff class: Very low
Capacity of the most limiting layer to transmit water (Ksat): High (1.98 to 5.95 in/hr)
Depth to water table: About 6 inches
Frequency of flooding: None
Frequency of ponding: None
Calcium carbonate, maximum in profile: 25 percent
Available water storage in profile: Moderate (about 6.9 inches)

Interpretive groups

Land capability classification (irrigated): None specified
Land capability classification (nonirrigated): 2w
Hydrologic Soil Group: A/D
Hydric soil rating: No

Typical profile

H1 - 0 to 11 inches: sandy loam *
H2 - 11 to 35 inches: sandy loam
H3 - 35 to 48 inches: loamy sand
H4 - 48 to 60 inches: sand

Properties and qualities

Slope: 0 to 2 percent
Depth to restrictive feature: More than 80 inches
Natural drainage class: Somewhat poorly drained
Runoff class: Very low
Capacity of the most limiting layer to transmit water (Ksat): High (1.98 to 5.95 in/hr)
Depth to water table: About 6 inches
Frequency of flooding: None
Frequency of ponding: None
Calcium carbonate, maximum in profile: 25 percent
Available water storage in profile: Moderate (about 6.9 inches)

Determining Plant Available Water

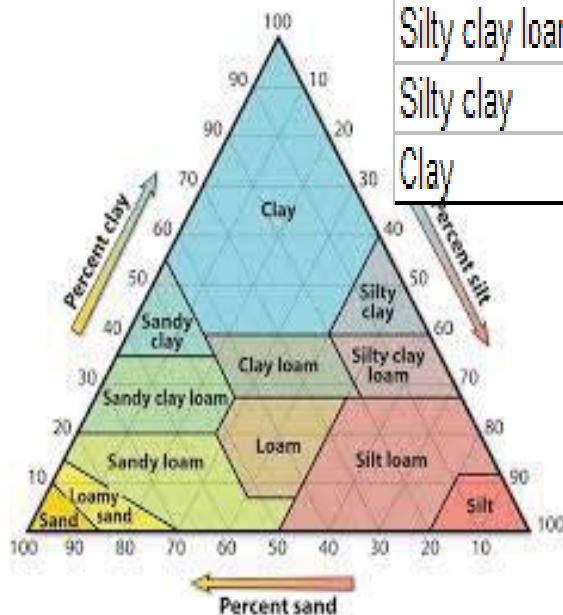

<i>Textural class</i>	<i>Water holding capacity, inches/foot of soil</i>
Coarse sand	0.25 - 0.75
Fine sand	0.75 - 1.00
Loamy sand	1.10 - 1.20
* Sandy loam	1.25 - 1.40
Fine sandy loam	1.50 - 2.00
Silt loam	2.00 - 2.50
Silty clay loam	1.80 - 2.00
Silty clay	1.50 - 1.70
Clay	1.20 - 1.50

<i>Depth from soil surface</i>	<i>Depth of layer</i>	<i>Soil texture</i>	<i>Water holding capacity</i>	<i>Available water</i>	<i>Available water</i>
<i>Inches</i>	<i>Feet</i>		<i>In/ft</i>	<i>In/layer</i>	<i>In/5 ft</i>
Soil A					
0-6.0	*	0.5	Loamy fine sand	1.2	0.6
6.0-24		1.5	Loamy fine sand	1	1.5
24-60		3	Fine sand	0.7	2.1
Total					4.2
Soil B					
0-12.0		1	Silty clay	1.5	1.5
12.0-30		1.5	Silty clay loam	2	3
30-60		2.5	Loamy sand	1.1	2.7
Total					7.2

Trickl-eez Irrigation - Chris Lattak
(chris@trickl-eez.com)

Target area

- A hop plant's tap root can extend down 15'
- The majority of a hop plant's roots are in the top 6" to 8" – where soil biologicals, nutrients and oxygen are located, but the roots will extend down 4' and out well into the drive middle (remember Mycorrhizae/root symbiosis)
- Irrigation tubing with emitters every 24" will have a solid wetted area the length of the row and up to 3' wide on medium to light soils (possibly more on heavier soil)
- Irrigation depth (and width) depends on soil type and the length of the irrigation set





"Mycorrhizal fungi increase the surface absorbing area of roots 100 to a 1,000 times, thereby greatly improving the ability of the plant to access soil resources. Several miles of fungal filaments can be present in less than a thimbleful of soil. Mycorrhizal fungi increase nutrient uptake not only by increasing the surface absorbing area of the roots, but also release powerful enzymes into the soil that dissolve hard-to-capture nutrients, such as organic nitrogen, phosphorus, iron and other "tightly bound" soil nutrients. This extraction process is particularly important in plant nutrition and explains why non-mycorrhizal plants require high levels of fertility to maintain their health. Mycorrhizal fungi form an intricate web that captures and assimilates nutrients, conserving the nutrient capital in soils." - Mycorrhizal Applications, Inc.

Trickl-eez Irrigation - Chris Lattak
(chris@trickl-eez.com)

Mycorrhizae

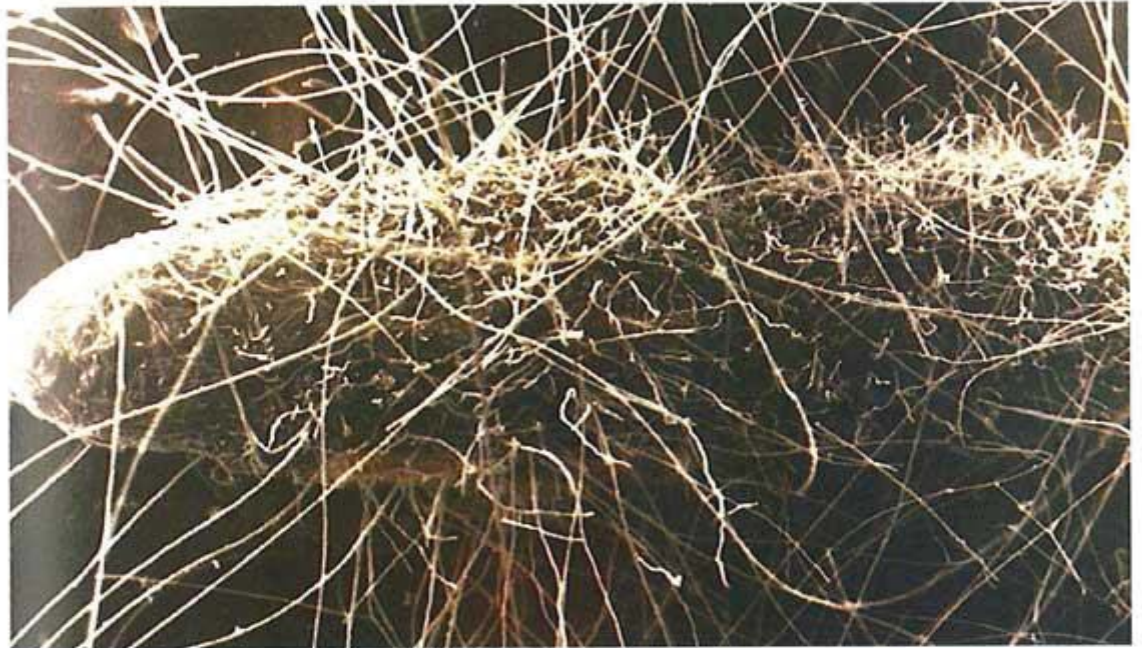
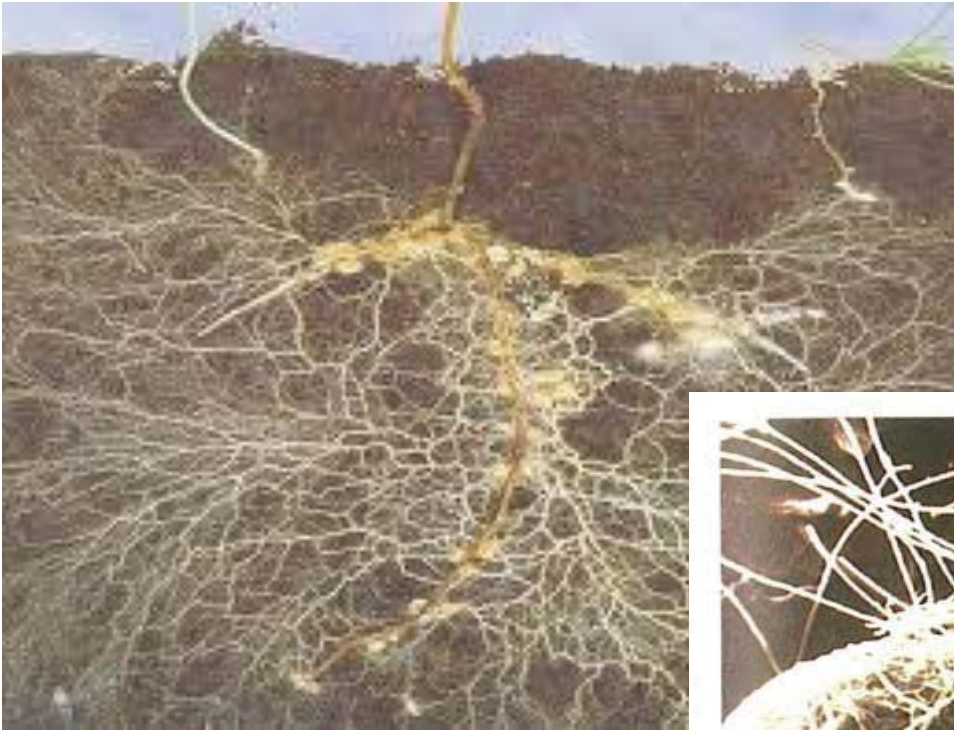

Mycorrhizal fungi, extending from a root—and increasing the plant's ability to obtain nutrients and water. Courtesy Mycorrhizal Applications, www.mycorrhizae.com.

Trickl-eez Irrigation - Chris Lattak
(chris@trickl-eez.com)

Water Holding Capacity

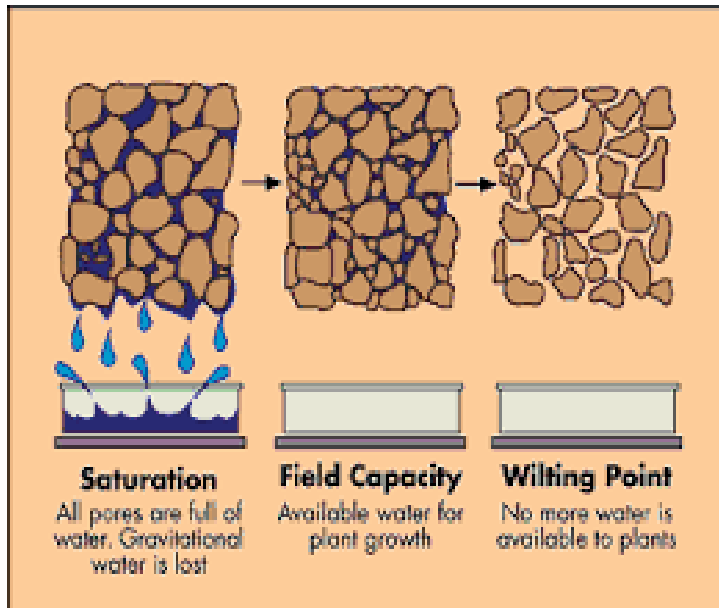

	~Inches of water/foot of soil~			Textural class	Water holding capacity, inches/foot of soil
	Sand	Loam	Silty clay loam		
Saturation	5.2	5.8	6.1	Coarse sand	0.25 - 0.75
Field Capacity	2.1	3.8	4.4	Fine sand	0.75 - 1.00
Permanent wilting point	1.1	1.8	2.6	Loamy sand	1.10 - 1.20
Oven dry	0	0	0	Sandy loam	1.25 - 1.40
Gravitational	3.1	2	1.7	Fine sandy loam	1.50 - 2.00
Water holding capacity	1	2	1.8	Silt loam	2.00 - 2.50
Plant available	0.5	1	0.9	Silty clay loam	1.80 - 2.00
Unavailable	1.1	1.8	2.6	Silty clay	1.50 - 1.70
				Clay	1.20 - 1.50

Soil Biology can access water and nutrient reserves not available to a plant's roots and root hairs
Plant root and root hairs can, generally, access 25-30% of the moisture content of the soil, as measured at full field capacity

- b. The remaining 70-75% is so tightly held/adsorbed by soil colloids and aggregates that they are not plant available
- c. **Mycorrhizal Fungi and Bacteria are capable of accessing an additional 40% of the water held in the soil**
 - i. Mycorrhizae increase the surface absorbing area of plant's roots by 100 – 1,000 times
 - ii. Mycorrhizae release enzymes that dissolve hard to capture nutrients that are tightly bound in the soil (ie. N, P, Fe) for their own life processes, but will also transfer them directly to the plant's roots

Why are we applying water?

Evapotranspiration (ET)

Loss of water from soil evaporation and by transpiration from the plants growing thereon

Region: Southwest
 Station: Scottsdale
 Model: Michigan State University AgBioResearch
 Potential Evapotranspiration
 Select Start Date: Jul 11
 Select End Date: Jul 21 2013
 [Execute]

MICHIGAN STATE UNIVERSITY

Extension



Scottsdale Potential Evapotranspiration Daily Summary (Report issued 2/13/2014 12:03)

Missing temperature data for dates: 2013-03-30 - 2013-04-17

Note that frozen precipitation amounts may not be accurate



Day	Date	Max Temp (°F)	Min Temp (°F)	Ave Temp (°F)	Rainfall (in.) Today	Rainfall (in.) Since 7/11	Chance of Rain	Reference Potential Evapotranspiration (in.) Daily Total	Reference Potential Evapotranspiration (in.) Since 7/11
Thu	7/11/13	79.6	55.5	67.5	0	0	--	0.21	0.21
Fri	7/12/13	82.7	53	67.8	0	0	--	0.21	0.42
Sat	7/13/13	86.5	66.5	71	0	0	--	0.21	0.63
Sun	7/14/13	90.1	66	77.6	0	0	--	0.21	0.84
Mon	7/15/13	91.7	70.4	81.1	0.9	0.9	--	0.12	0.96
Tue	7/16/13	92.5	72.5	82.5	0	0.9	--	0.2	1.16
Wed	7/17/13	90.7	72.1	81.4	0	0.9	--	0.2	1.36
Thu	7/18/13	93.2	73	83.1	0	0.9	--	0.22	1.58
Fri	7/19/13	93.3	75.5	84.4	0	0.9	--	0.25	1.83
Sat	7/20/13	88.3	69.5	78.9	0	0.9	--	0.22	2.05
Sun	7/21/13	88.8	61.8	75.3	0	1	--	0.19	2.24

Crop Coefficients

Crop	K _{cbini}	K _{cbmid}	K _{cbend}
I. Tropical Fruits and Trees			
Banana			
- 1 st year	0.15	1.05	0.90
- 2 nd year	0.60	1.10	1.05
Cacao	0.90	1.00	1.00
Coffee			
- bare ground cover	0.80	0.90	0.90
- with weeds	1.00	1.05	1.05
Date Palms	0.80	0.85	0.85
m. Grapes and Berries			
Berries (bushes)	0.20	1.00	0.40
Grapes			
- Table or Raisin	0.15	0.80	0.40
- Wine	0.15	0.65	0.40
Hops	0.15	1.00	0.80
n. Fruit Trees			
Almonds, no ground cover	0.20	0.85	0.6019
Apples, Cherries, Pears ²⁰			
- no ground cover, killing frost	0.35	0.90	0.6519
- no ground cover, no frosts	0.50	0.90	0.7019
- active ground cover, killing frost	0.45	1.15	0.9019
- active ground cover, no frosts	0.75	1.15	0.8019



Water Use by Hops

30" during the Season - When? How Much?!?!

“A goal without a plan is just a wish.”

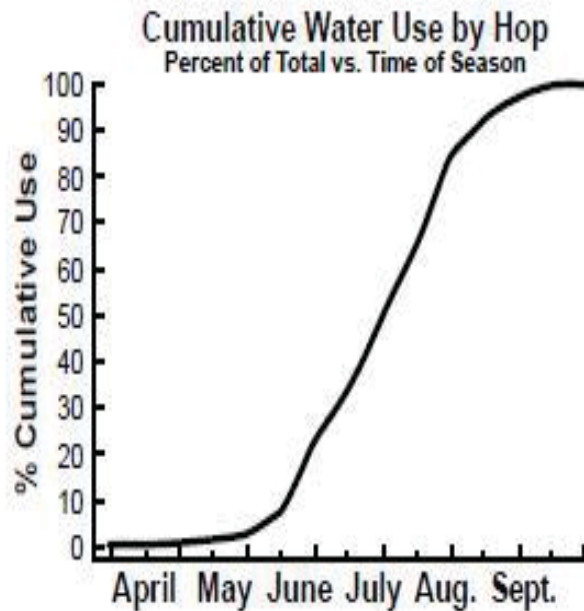

Fig. 1. Cumulative water use of hop during the growing season.



- Goal = 30" in a 5 month period
- 90% during heavy growth period between training and flowering (Mid May to Late July)
- Deficit irrigation will stunt growth and result in fewer and smaller flowers
- From April through August 2013, the base Evapotranspiration (ET) Rate in Southwest MI was 22.58". Take into account a 1.2? (not 1.0) coefficient for hops and that is about 27" for the 2013 season.

How much water using drip?

We still need to take into account significant rain events (generally > .25")

Irrigation is generally needed in most areas of the United States to satisfy the water needs of hop plants. By the second year, hops need roughly 16 gallons per plant per week during the hottest parts of the summer.⁹ Hop plants do not thrive in heavy, waterlogged soils, which can increase the incidence of many diseases. Drip irrigation that can deliver water directly to plants tends to be the most efficient watering system. Researchers at the Northwest Michigan Horticultural Research Station have successfully employed a computer-operated RAM tubing drip irrigation system with emitters every 2 feet and an output of .42 gallon per hour. In this soil-moisture-based system, underground sensors determine when water is needed and soil moisture levels are maintained at optimum levels. RAM tubing provides uniform output from each emitter, in spite of elevation changes or length of drip line. Though this type of system has higher initial costs, it is more efficient than other systems because it operates only when soil moisture levels are low.

- In the height of summer, a hop plant can require 16gal/plant/week.
- With 3.5' plant spacing and 14' b/n rows, 16ga/plant/week using RAM w/ 24" emitter spacing at .42gph = 1.85"/week (run time of 21.8 hrs/wk) for a 4' wide area running the entire length of the row.
- However, giving drip a 95% efficiency rating, we are actually only applying just over .08"/hr, SO... 21.8hrs/wk is actually applying app. 1.75 inches/week.
- To achieve 1.85", taking into account the 95% efficiency, divide our run time of 21.8hrs by .95.
- Giving us a target of irrigating 23 hrs/wk at the height of summer (2"/week).

Extension Bulletin E-3083 - New - January 2010

**Sustainable Hop Production
in the Great Lakes Region**

**MICHIGAN STATE
UNIVERSITY
EXTENSION**

Trickl-eez Irrigation - Chris Lattak
(chris@trickl-eez.com)

Irrigation tips

- Match emitter application rate and spacing to the soil type/organic matter (also remember that 1% OM = 1 acre inch of water holding capacity)
- Irrigate early in the day to keep water cool
- Alternate days to allow time for soil to dry down
- Pulse irrigate in lighter soils; keep the soil moist, not wet; and do not flush oxygen out of the root profile by over watering
- Occasional deep irrigation (not after fertigation) to send roots deep and flush salts
- Boots on the ground – numbers from ET, moisture sensors, etc. will never fully replace what you see and touch

Moisture sensors in trickle irrigated vegetables

- Sample representative soils – 2 or more locations
- Probe should be approximately 12” from an emission point
- Best to measure at least two depths
 - First probe at 6-8”
 - Second probe at 18”
 - More depending on crop root structure
- Monitor the probes often
- Error on the side of over irrigating rather than under irrigating

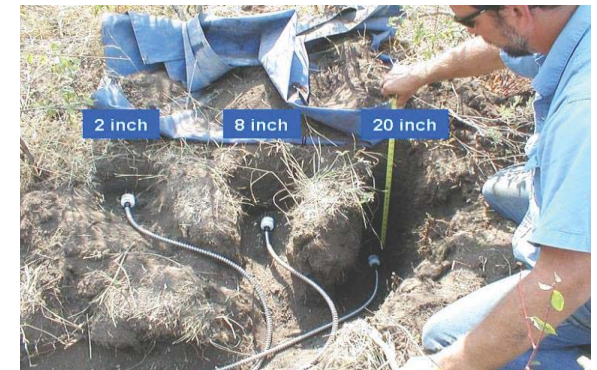

Trickl-eez Irrigation - Chris Lattak
(chris@trickl-eez.com)

Moisture Monitoring / Moisture Sensors

Should we be using ET, water/moisture content, soil tension, something else?

- We are continuously trialing products, all with benefits and detriments
- Simple, reasonably priced systems track information / provide measurements
 - Temp., humidity, ET, rainfall, wind, moisture sensors
 - Information for you to interpret and a basis to make decisions
- Complex systems – everything and the kitchen sink, when all you really need is the sink and maybe a toaster oven
 - You still have to interpret
 - System can control irrigation - pumps, zones, duration, etc
 - Mixed results
- Soil Tension based systems???
- What issues are we seeing with current systems?

Typical Irrigation Scheduling

(year following establishment)

- 3 to 4 days per week (every other day)
- 1 to 2 (maybe even 3 in light soils, or early in the establishment year) times per day depending on soils
- at the height of the season, as much as 3 1/2 hrs per day, everyday (or 7 hours every other day)
- An occasional deep soak (send the roots deep), but not immediately following a nutrient application
- In the year of establishment, shorter irrigation sets, but more often, are more appropriate for the existing, smaller root structure. However, we do want to encourage the roots to delve deeper as the plant matures.

What is water's function within a plant? In a plant's environment?

- maintaining cell turgidity for structure and growth;
- transporting nutrients and organic compounds throughout the plant;
- carrying the dissolved sugar and other nutrients throughout the plant, as well as to the roots and soil;
- comprising much of the living protoplasm in the cells;
- serving as a raw material for various chemical processes, including photosynthesis;
- and, through transpiration, buffering the plant against wide temperature fluctuations.

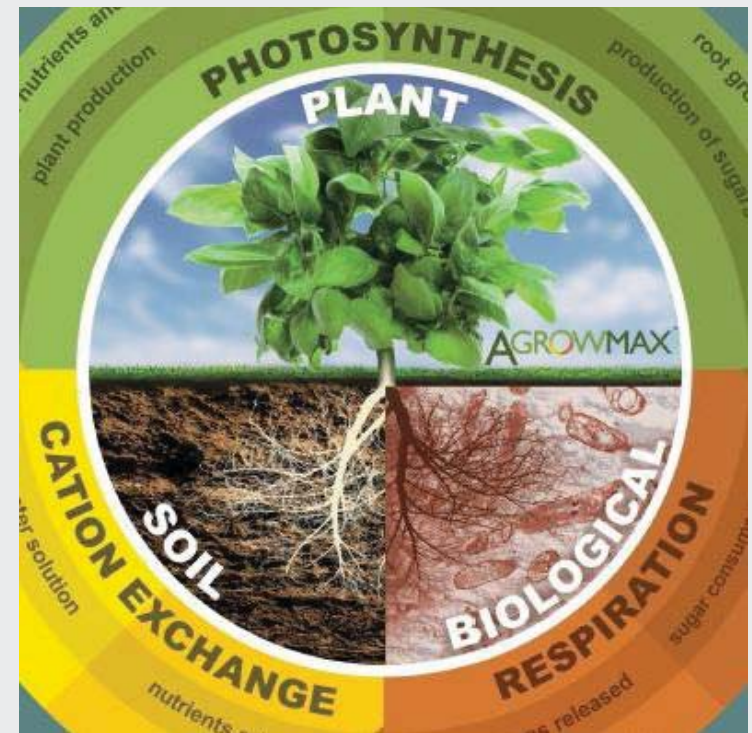

How does Capillary Action work?

- Capillary action: result of cohesion of water and adhesion of that water to the solid material around it
- As plants release water from their leaves (transpiration), a void is created.
- Water is drawn upward into plant due to its attraction to the walls of the xylem tubes within the stems.

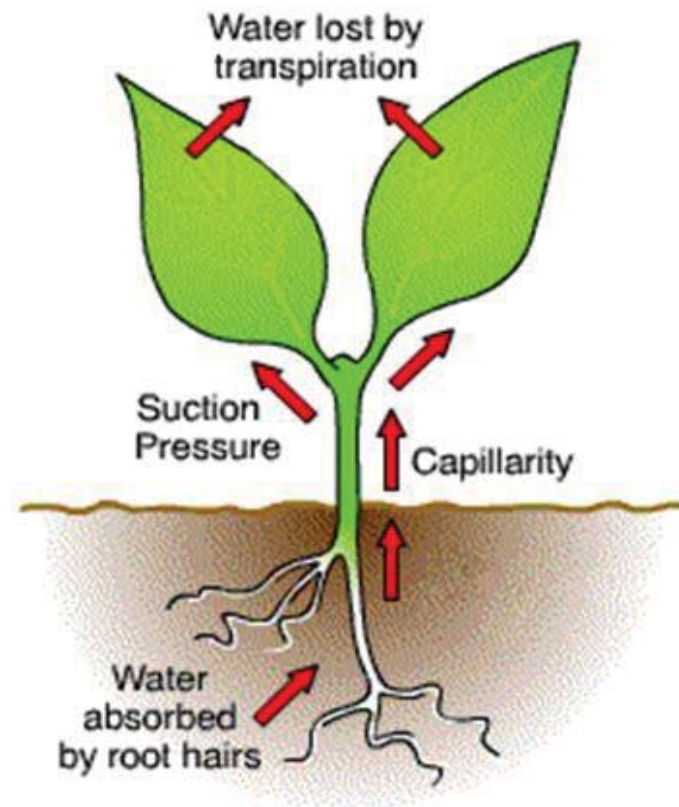



Photosynthesis

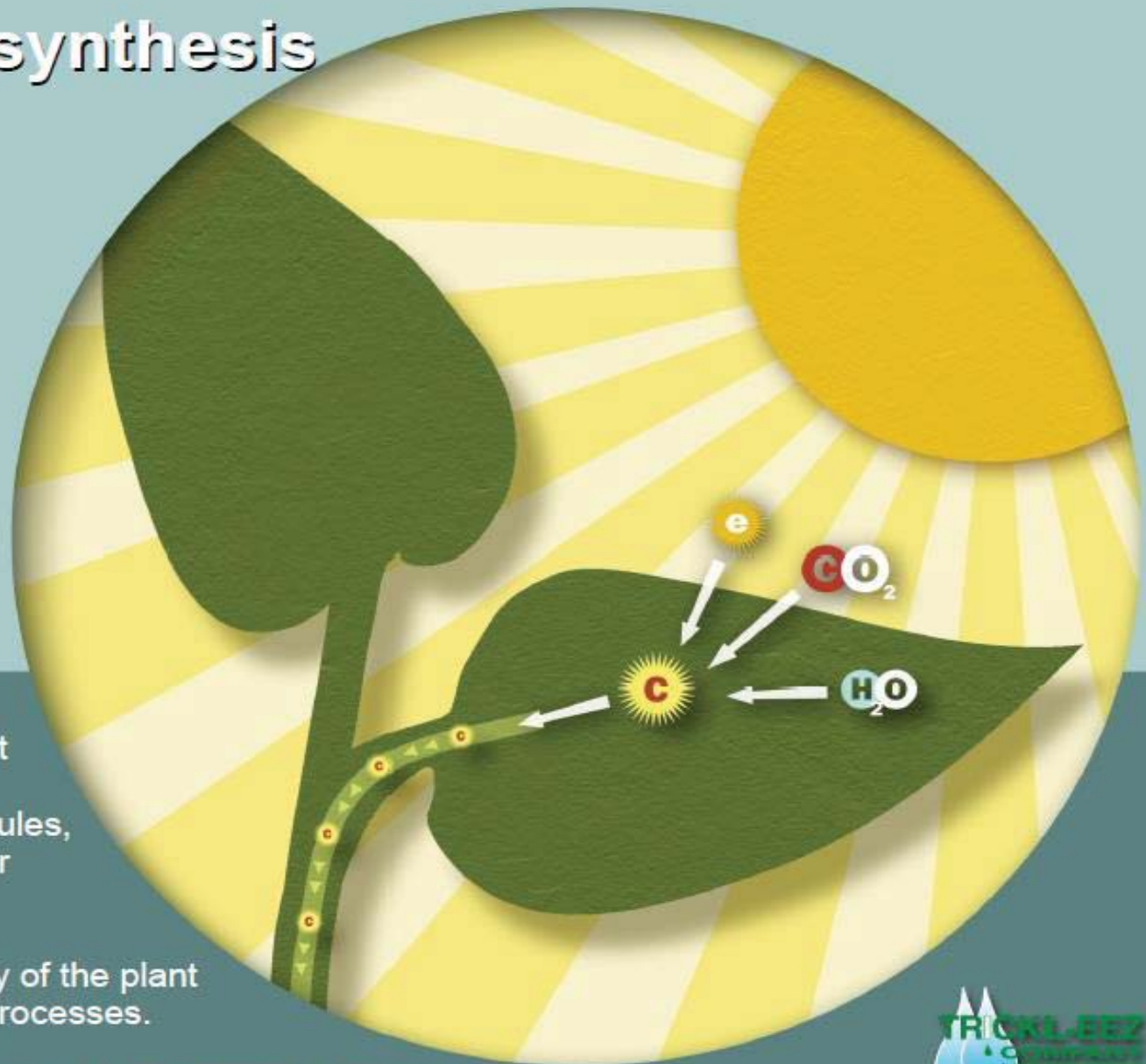

Carbon dioxide, water, and energy from sunlight are combined to create energized carbon molecules, also known as sugars, or carbohydrates.

This is the energy supply of the plant and is used in all plant processes.

The plant sends the majority of the energy down to the roots.





Biological Respiration

Bacteria living in and around the root mass consume the carbohydrates from the root tips.

As the bacteria eat they release two byproducts into the soil:

1. Acids and exudates.
2. Positively charged hydrogen ions.

These byproducts perform two important roles for the plant:

1. To enhance plant growth.
2. To provide access to nutrients in the soil.

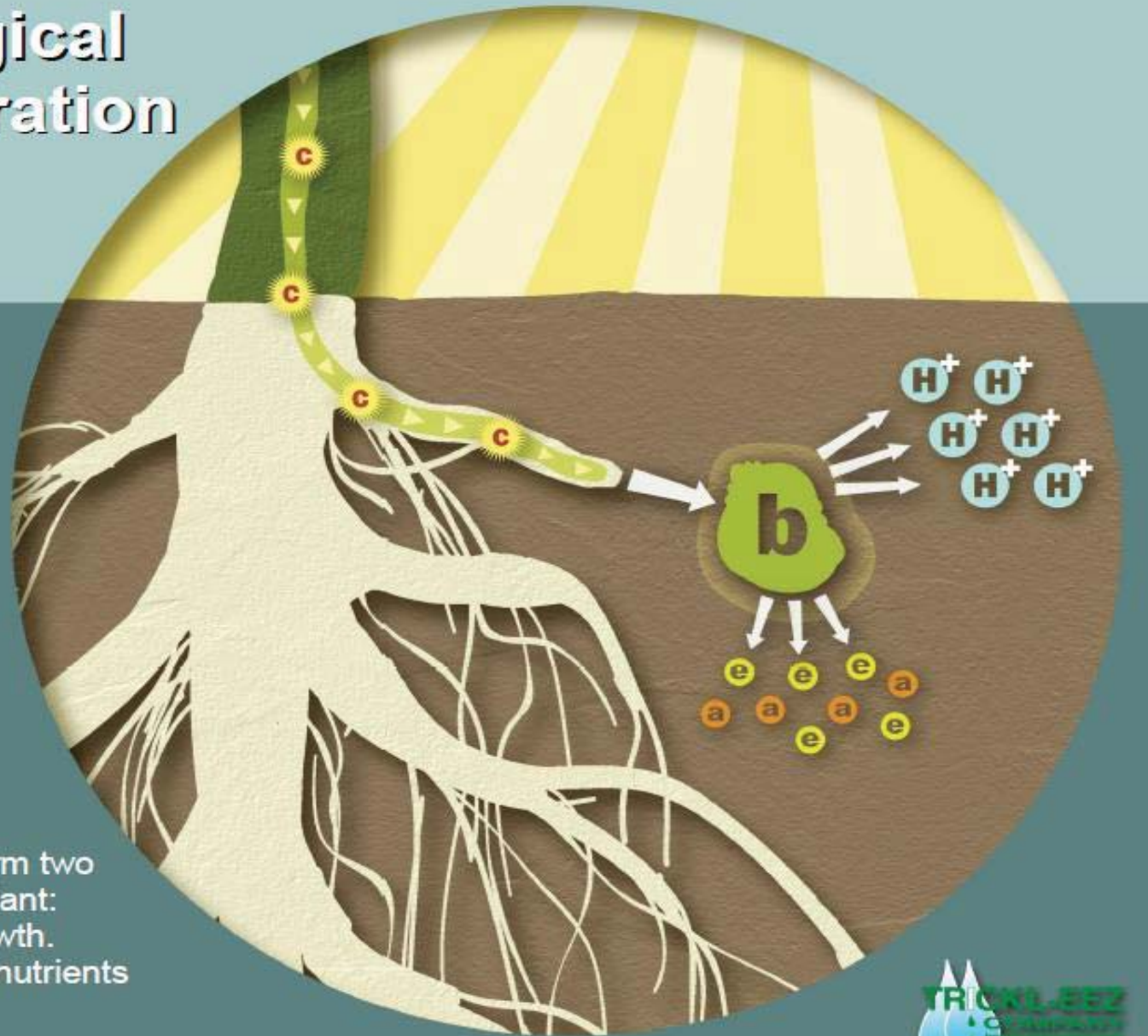



Root Growth

The acids and exudates released by the bacteria promote and accelerate the growth of the plant.

These carbon-rich byproducts make up the largest portions of the plant body.

When present in the soil, they support rapid root growth.

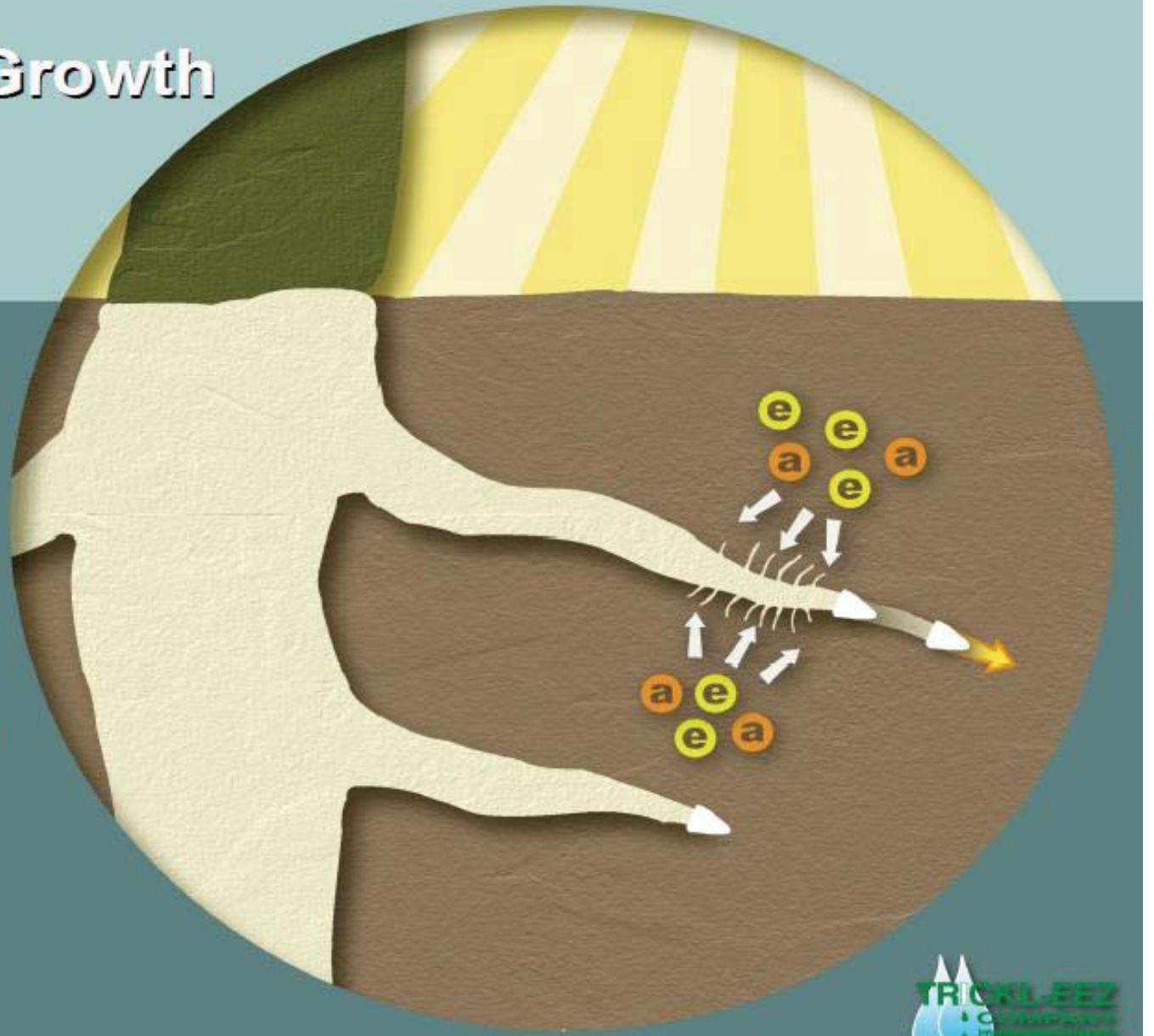



Cation Exchange

Soil already contains a vast amount of unavailable nutrients. These positively-charged nutrients are tied to negatively-charged soil particles.

Positively-charged hydrogen ions released by bacteria replace the nutrients bonded to soil particles, thereby making them available to the plant.

The hydrogen ions also lower the pH of the soil.

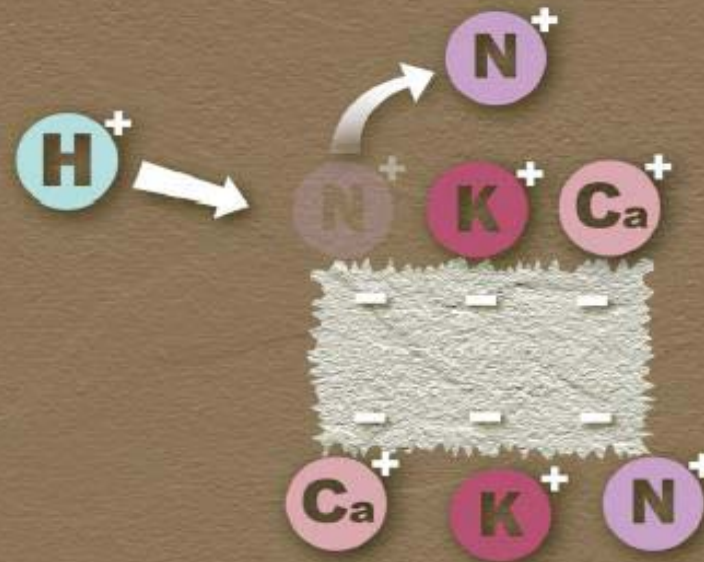



Nutrient & Water Uptake

Water and the newly released nutrients are absorbed through the roots and travel upwards in the plant.

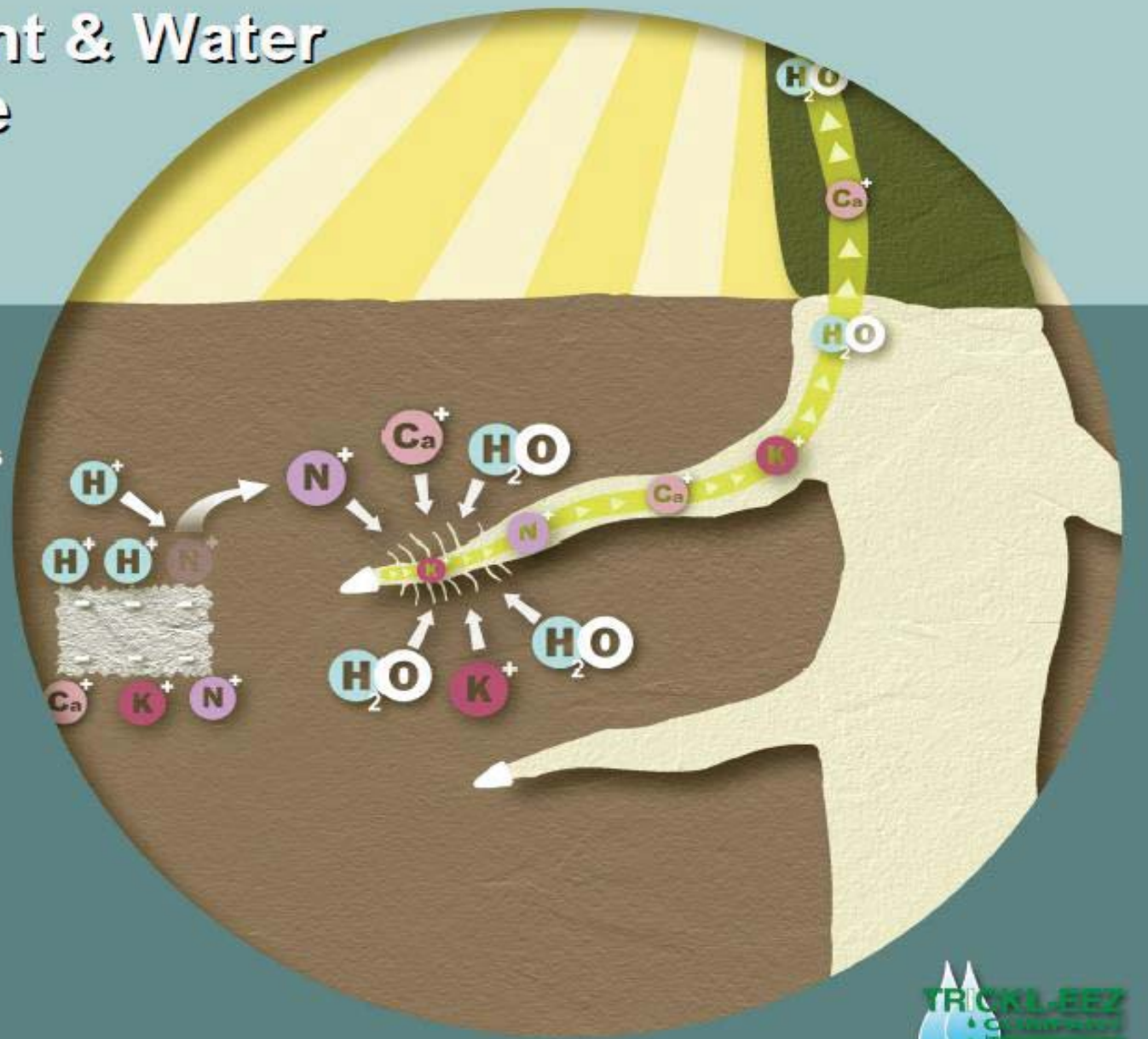

Trickl-eez Irrigation - Chris Lattak
(chris@trickl-eez.com)



Upper Plant Growth

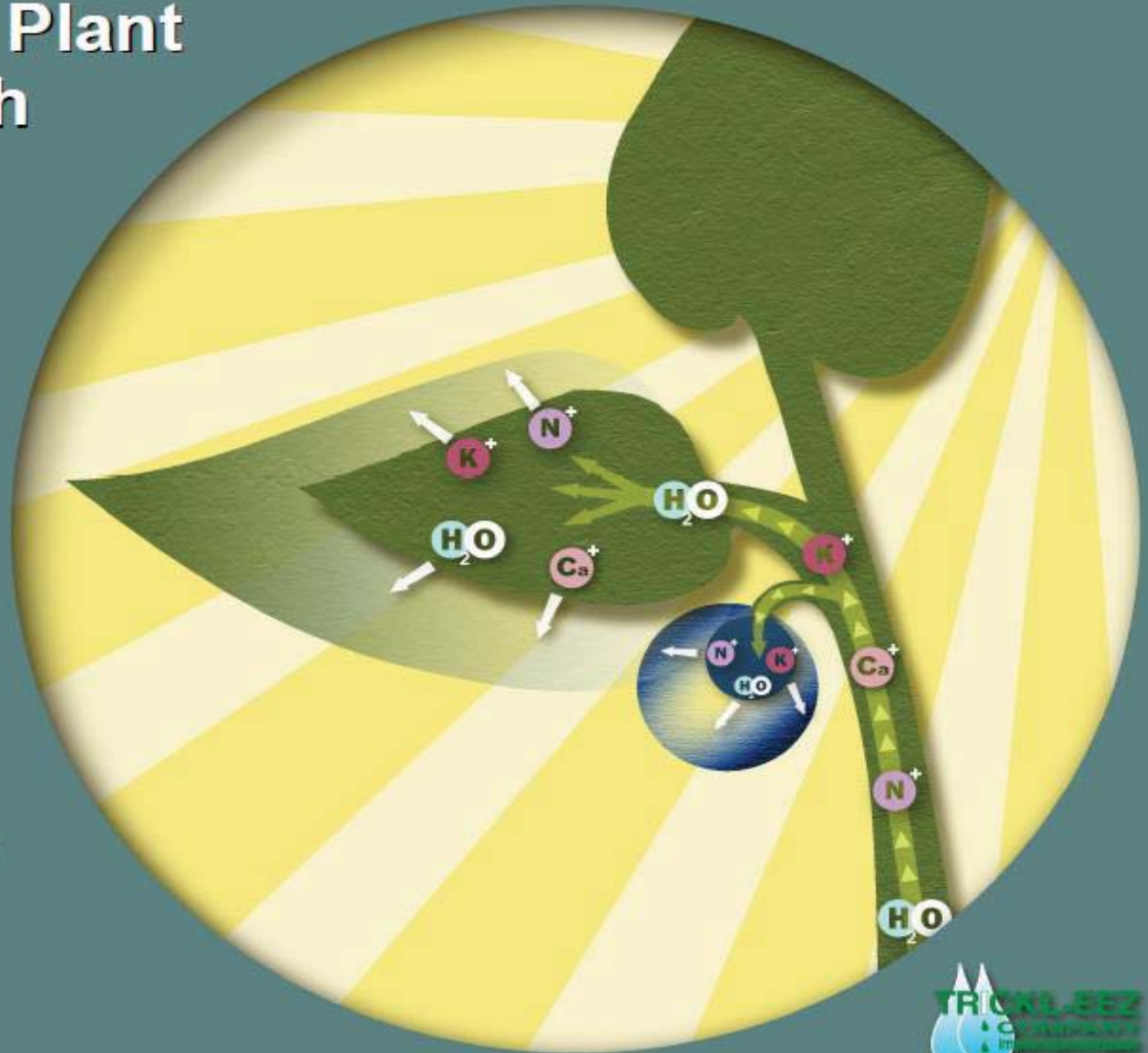

Nutrients are critical to foliage growth and fruit production.

Balanced nutrient levels promote the health of the plant and increase the quality of the fruit.



Trickl-eez Irrigation - Chris Lattak
(chris@trickl-eez.com)

Soil/Plant/Biological/Water/Nutrition Interaction – What are the primary takeaways?

- 1) Soil (Nutrients and Biology) work integrally with plants
 - a. Soil is the plant's digestive system
 - b. Plants feed the soil biology; in an extremely healthy relationship
 - i. 70% of a plant's photosynthates (simple sugars/energy) are sent through the roots out to the soil biology
 - ii. If you had 100# of plant above ground, 100# below, then 460# of growth is sent into the biosystem as exudates
- 2) 2 Models of Plant Nutrition
 - a. Accepted Standard – Plants absorb nutrition directly as simple ions from the soil solution. **THIS IS ENTIRELY DEPENDENT ON SUFFICIENT MOISTURE**
 - i. "Glorified Hydroponics" - soil as hydroponic medium
 - ii. Plants dependent on applied nutrients, water, and only plant roots
 - iii. Soil biologicals and interactions are minimal
 - b. Real World – nature's way – Plants absorb nutrients as microbial metabolites produced by the total soil microbial system (soil food web)
 - i. The soil food web – Bacteria, Fungi, Nematodes, Actinomycetes, Protozoa feed on root acids % exudates (sugars, amino acids, lipids) and minerals, nutrition and organic residues in the soil profile

Soil/Plant/Biological/Water/Nutrition Interaction

- 3) Microbial populations need nutrients
 - a. Microbials digest sugars, absorb nutrients from the soil matrix to build and reproduce, recycle through the soil food web again and again, eventually turning into stable humic substances
 - b. Nematodes eat bacteria and produce waste that is released as plant available nutrients (amino acids, essential fatty acids, organic acids), and metabolites combined with minerals/nutrients
- 4) Soil Biology can access water and nutrient reserves not available to plant's roots and root hairs
 - a. Plant root and root hairs can, generally, access 25-30% of the moisture Content of the soil, as measured at full water holding capacity
 - b. The remaining 70-75% is so tightly held/adsorbed by soil colloids and Aggregates that they are not plant available
 - c. Mycorrhizal Fungi and Bacteria are capable of accessing an additional 40% of the water held in the soil
 - i. Mycorrhizae increase the surface absorbing area of plant's roots
By 100 – 1,000 times
 - ii. Mycorrhizae release enzymes that dissolve hard to capture nutrients that are tightly bound in the soil (ie. N, P, Fe) for their own life processes, but will also transfer them directly to the plant's roots

SOIL ECOLOGY & THE SOIL FOOD WEB

Copyright May 1975 © Revised in 2003

Originally written by Michael Martin Melendrez in 1974

The soil food web is the plant's digestive system

Why We Need a Soil Food Web

Plants depend on beneficial soil organisms to help them obtain nutrients and water from the soil, to prevent nutrient losses, to protect them from pathogens, and to degrade compounds that could inhibit growth. Each class or type of microorganism plays unique roles in these processes. Soil organisms create a living, dynamic system that can do all these things, but must be managed properly for best plant growth.

A spoonful of healthy soil contains millions of beneficial microscopic organisms of various kinds that perform vital "functions" in the root zone that can bring plants to health, if soil conditions are managed in ways that allow the microbes to live and work. These organisms include beneficial species of bacteria, fungi, protozoa, microarthropods and nematodes that never cause disease or become pests.

In healthy soil ecosystems, while nutrient cycling and productivity increases, nutrient loss is minimized. What makes this possible is the complexity of the soil food web. The greater the interaction of decomposers, their predators, and the predators of those predators the more tightly nutrients cycle from stable forms in soils to plants, and back again (Coleman et al, 1985; 1992).

What Happens to Soil Nutrients Without a Functioning Food Web?

When we add fertilizers containing N, some of the fertilizer will dissolve and diffuse directly to the roots and be taken up, helping the plant to grow. Much of the excess N is in danger of being leached away. Without large numbers of soil organisms that can "capture" excess N, retention in the soil doesn't happen and the nutrients can be leached into the groundwater. Other nutrients, like phosphorus, iron, manganese, zinc & copper, are rapidly converted into insoluble (less available) forms.

The solution: Protect the nutrients and cycle them! Apply the microbes that make up the food web and feed them. In return they will retain and cycle plant nutrients. And they will also do a great deal more.

What Happens to Plants Without a Functioning Soil Food Web?

Disease organisms are not suppressed; and therefore multiply and threaten plants. The loss of symbiosis with soil microorganisms results in reduced ability to take up water and nutrients. Not only are plant growth adversely affected but resistance to temperature and moisture stress is reduced as well.

The lasting solution...

Restore the health of the soil ecosystem, the soil food web.

A highly populated and balanced soil food web will:

1. Create humus by decomposing organic matter
2. Improve soil structure by binding particles together and creating microaggregates
3. Protect roots from diseases and parasites
4. Retain nitrogen and other plant nutrients
5. Slowly release retained nutrients to the plant
6. Produce enzymes and hormones that help plants grow and resist stress
7. Decompose pollutants that enter your soil

What else should we do with drip?

Apply Nutrients (N, C, micros).

Water requirements seem to shadow Nitrogen requirements

Starving Continued

So we know hops need water, but how much? Several publications say hops need 30 inches of water per season. But soil type contributes to water holding capacity and percolation and irrigation methods determine frequency and volume. So sorry, gang...no easy answer.

GVH advocates drip irrigation and can point you to equations that will help you calculate volume and duration based on your needs. But regardless of the soil situation, we can see from the chart that hops want nearly 100% of their 30-inches between mid May to Mid July. Deficit irrigation during this period will stunt growth and result in fewer and smaller flowers.

So what does water have to do with nitrogen? We know hops require lots of nitrate (NO₃⁻) nitrogen for all that biomass production. Soil type will also determine just how much N is required, but in general plan on 80-150 lbs/acre. That's a load of N! But then again think about how fast these plants are growing. In the heat of late June these plants will grow 10-14 inches per DAY. How much would you need to eat if you were growing that fast?

The nitrogen uptake curve for hops looks something like this:



The vast majority of N is required within a narrow 6 week window. Remember this is *nitrate* N. Organic growers are warned that biological N obtained from manures, fish extracts, compost, etc requires several weeks to months to undergo transformation from ammonium (NH₃⁺) form to nitrate (NO₃⁻) form before it becomes available to the hops.

Excessive irrigation or rain will leach the nitrate from the soil. This is the link between water and nitrogen. Hops need a lot of water, but also a lot of N during the same period. Ah, the dance of horticulture continues...

By Plant Geek James Altwies, *Gorst Valley*
(chris@trickl-eez.com)

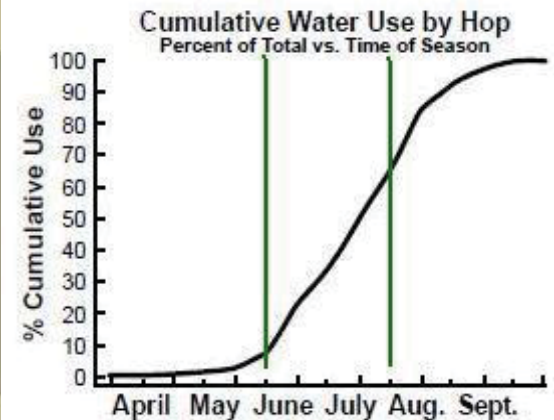

Washington

Beeriodic Table of Elements

<i>Humulus lupulus</i>	Scientific name for hops
736	Atomic Number of humulone
Hu	Beeriodic Table Elemental Symbol
362.00165984	Atomic Weight of humulone

Copyright 2009 Gorst Valley Hops LLC

Injecting Nutrients through our drip

- Timing
 - Preferably twice per week, at a minimum.
 - Often every time we irrigate (timers and proportional injectors are irreplaceable)
 - Allow time for water to “energize the system” (fill all the pipe and tubing with water), then inject, followed by a period to flush the nutrient out of the system before the end of the cycle



Soil, Tissue, Sap Analysis

- **Soil analysis** - for monitoring soil fertility levels and providing baseline information
 - Only tells us what is plant available in the top 4-6” of the soil
- **Tissue analysis** - can account for the plant-available nutrient pools present at multiple soil depths, and current nutritional status of the plant as evidenced by plant’s uptake
 - deficiency in nutrient uptake will be revealed only 4 or 6 weeks after the actual nutrient deficiency was caused
- **Sap analysis** – “blood test for plants”, compares sap from both young and old tissue, compares them to key indicators, and measures the current amount of bioactive nutrients available in the sap to support metabolic activities and plant growth – Crop Health Labs, Bellville, Ohio
 - Detects deficiencies within just a few days, 3-4 weeks before a tissue sample would show them, allowing proactive application prior to symptoms, or yield loss

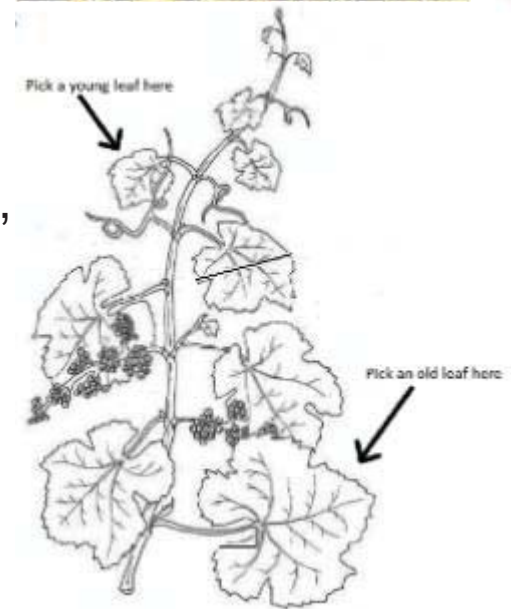

But what about Water Quality?

**And its affect on the soil,
soil pH, hydration,
nutrient application,
spray material . . .**



Water Analysis Report

Job Name Nye Heritage Farms and Apple Barn 3 **Company** Advancing Eco-Agriculture
Contact John Kempf **Sample ID** 224941
Rep **Lab Number** 9129
Submitted By Craig Dow **Run Date** 4/14/2015

Sample Location BarnWell
Sample Name HmFrmSpry

Notes

pH 7.2
Hardness ppm 496.1
Hardness Grains /gal 29.01
Conductivity mmhos/cm 1.00
Sodium Adsorbtion Ratio 0.12

This level of pH and hardness is a serious problem for mixing pesticides, foliar nutrients will have minimal effectiveness. At a minimum this will need to be buffered with an acid down to 6.2 pH, 5.5 to 5.7 pH would be ideal for a majority of pesticides.

Conductivity and Sodium do not present a problem here. There is room for acid buffering without immediate risk of crop burn.

		ppm	meq/L	lbs/A in	
Calcium	Ca	115.9	5.80	26.34	This water will add a significant amount of Ca & Mg, whether this is beneficial depends on soil type. A high pH soil will require 15-25% more of this water for the same hydration compared to soft or buffered sources.
Magnesium	Mg	50.2	4.18	11.41	
Potassium	K	1.4	0.04	0.33	
Sodium	Na	6.2	0.27	1.40	
Iron	Fe	0.1		0.03	
			meq/L	lbs/A in	
Total Alkalinity		395.0		89.77	With this level of bicarbonates expect to see >50% reduction in fertilizer efficiency. This is especially true for fertilizer applied with the water but existing fertility is also affected when this is the crops primary source of moisture.
Carbonate		0.0	0.00	0.00	
Bicarbonate		482.0	7.90	109.55	
Chloride		38.0	1.08	8.64	
Sulfate		115.8	2.43	26.33	
Salt Concentration		640.0		145.45	
Boron		0.02			
Cation/Anion Ratio			0.90		

What to do: If possible it is recommended to find a different source of water for spraying purposes, ie collect rain water. If there are no viable alternatives either acid buffering or an RO system is needed. Acids include phosphoric, sulfate, acetic and citric acids. The acid requirements of this water are high enough to make an RO system attractive for spraying purposes.

For irrigation purposes it is often difficult to find alternative water sources. The treatment needs depend largely on volume needs. For occasional use on field crops injecting acid can be the best route, particularly important if we will be injecting fertilizer. For routine use or on larger acreages a sulfur burner becomes the best option. For steady use on smaller areas such as in green houses an RO unit can certainly be economically viable. These are the proven techniques, there are also some alternative methods and water structuring devices that are effective on some water types and may be worth testing and evaluating.

Water Quality & Reading a Water Analysis

Emphasis on
pH,
Hardness,
&
Bicarbonates

Irrigation Water Guidelines

SOIL FIRST CONSULTING

Parameter	Definition and Effects on Plant Growth
pH	The degree of acidity (or alkalinity) of the sample. A pH of less than 7.0 is acidic, 7.0 is neutral and above 7.0 is alkaline. This needs to be adjusted (buffered) first, before tank mixing. 5.5 – 6.0 (ideal) provides the best conditions for irrigation & tank mixing. > 7.0 can cause tank mix problems.
Conductivity EC (electrical conductivity) 1 EC unit = 640 ppm	This test is used to determine the electrical conductivity (EC) of the water. The higher the salt content, the greater the flow of electrical current. The lower the level, the more you can tank mix. < 1.5 desired range. > 1.5 potential problem. > 3.0 will burn under certain conditions.
Sodium Adsorption Ratio (SAR)	This is an expression of the sodium hazard of irrigation water. It is the measure of the proportion of sodium to calcium and magnesium in the water. The SAR is also an index of the sodium permeability hazard as water moves through the soil. The main problem with a high sodium concentration is its effect on the physical properties of soil. This breakdown disperses the soil clay and causes the soil to become hard and compact when dry and reduces the rate of water penetration when wet. A breakdown in the physical structure of the soil can occur with continued use of water with a high SAR value. The effects of high SAR on the infiltration of irrigation water are dependent on the EC of the water. Generally, if the SAR is more than 10 times greater than the EC, then poor water infiltration will occur. < 6.0 desired range (will add Ca to the soil). > 6.0 (will strip Ca from the soil); will burn under certain conditions; the lower the level, the more you can tank mix.
Calcium	The calcium (Ca ⁺⁺) cation is generally found in all natural waters. When adequately supplied with exchangeable calcium, soils are friable and usually allow water to drain easily. This is why calcium in the form of gypsum is commonly applied to improve the physical properties of tight soils. Sodium will be leached from the root zone when the Ca ⁺⁺ replaces the Na ⁺ on the soil colloid. Irrigation water that contains ample calcium is most desirable. 40 – 120 ppm desired range.
Magnesium	The magnesium (Mg ⁺⁺) cation is also found in most natural waters. Together with calcium, Mg may be used to establish the relationship to total salinity and to estimate the sodium hazard. 6 – 24 ppm desired range.
Potassium	The potassium (K ⁺) cation behaves similarly to sodium in the soil and is commonly found in natural waters in only small amounts. 5 – 10 ppm desired range.
Sodium	The sodium (Na ⁺) cation is often found in natural waters due to its high solubility. When linked to chloride (Cl) and sulfide (SO ₄), sodium is often associated with salinity problems. High concentrations in the soil can adversely affect turfgrasses. Poor soil physical properties for plant growth will result as a consequence of continued use of water with high sodium levels. 0 – 50 ppm desired range.
Iron	The Iron (Fe ⁺) cation can be problematic in many irrigation waters. Excess iron can compete with other needed micro-nutrients and can cause staining of walkways or road surfaces. 2 – 5 ppm desired range.

Irrigation Water Guidelines

Total Alkalinity	Water alkalinity, simply stated, is a measure of the water's capability to neutralize added acids. Related to pH, alkalinity establishes the buffering capacity of water. The major chemicals that contribute to the alkalinity of water include dissolved carbonates, bicarbonates and hydroxides. High alkalinity can cause an increase in the pH of the soil (reducing micro-nutrient availability), the precipitation of nutrients in concentrated fertilizer solutions, and reduce the efficacy of pesticides and growth regulators. 1 – 100 ppm desired range.
Carbonate	Carbonates (CO ₃) are salts of carbonic acid (the acid formed when carbon dioxide dissolves in water), and are found in some waters. An alkalizing effect results when combined with calcium and/or magnesium. This effect is much stronger when it occurs in the presence of the sodium cation. < 50 ppm desired range.
Bicarbonate	Bicarbonates (HCO ₃) are also salts of carbonic acid and are common in natural waters. As soil moisture is reduced, calcium and magnesium bicarbonates can separate calcium from the clay colloid, leaving sodium to take its place. An increase of SAR in the soil solution will result. The overuse of a high bicarbonate irrigation water can contribute to a soil dominant in sodium, with a resulting reduction in water infiltration rates and soil gas exchange. < 120 ppm desired range.
Chloride	Chloride is an anion that is commonly found in irrigation water. Chlorides contribute to the total salt (salinity) content of soils. Necessary for plant growth in small amounts, while high concentrations will inhibit plant growth or be toxic to some plants. Irrigation water high in chloride reduces phosphorus availability to plants. < 140 ppm desired range.
Sulfate	Sulfate (SO ₄) is relatively common in water and has no major impact on the soil other than contributing to the total salt content. Irrigation water high in sulfate ions reduces phosphorus availability to plants. < 400 ppm desired range. > 400 ppm will acidify the soil.
Salt Concentration	The total dissolved solids (TDS) or total salt content is measured by determining the actual salt content in parts per million (ppm). A physiological drought condition can result from excess salts accumulating in the soil by increasing the osmotic pressure of the soil solution. Plants can wilt due to insufficient water absorption by the roots compared to the amount lost from transpiration, even though the soil may have plenty of moisture. (TDS = EC x 640) < 960 ppm desired range. > 1900 ppm or (3EC) = increased burn potential & poor tank mix options.
Boron	Necessary for plant growth in small amounts, adequate boron is found in most waters. Significant concentrations of boron can frequently occur in various water sources; therefore water should be tested to check for toxic amounts. Where concentrations exceed 1 ppm, it may be toxic to turfgrasses. Plant tolerance to boron may improve on soils high in lime, compared to non-calcareous soils. .2 – .8 ppm desired range.
Cation/Anion Ratio	Calcium and magnesium levels should always be higher than the sodium and chloride levels. 1:1 ideal ratio.

SOIL FIRST
CONSULTING

800-732-8873
soilfirst.com

SOIL FIRST
CONSULTING

800-732-8873
soilfirst.com

Trickl-eez Irrigation - Chris Lattak
(chris@trickl-eez.com)

Water Quality and Reading a Water Analysis

Primary Focus for foliar and irrigation nutrient and chemical application

- pH –
 - for foliar pesticide applications, ideal around 5.5 to 5.7
 - for irrigation, most crops we want no greater than 6.5
 - Blueberries, less than 6.0. preferably 5.0-5.5
- Hardness, Bicarbonates
 - Poor water quality, especially hard water/water high in bicarbonates, can have a very negative impact on effectiveness of plant nutrition and pesticides when applied as a foliar, or in an irrigation system
 - Hardness below 85ppm – we're good enough, still consider treatment of spray water with a conditioner
 - Above 150ppm – up to 50% more product to overcome binding effect of hard water
 - Above 200ppm without addressing hardness will result in nullification of most nutritionals, and significant negative effects on chemicals applied foliar, or via drip.

Trickl-eez Irrigation - Chris Lattak
(chris@trickl-eez.com)

Soil pH

Soil pH is a measurement of the ratio between Positive Hydrogen Ions and Hydroxyls. The more Hydroxyls in the soil, the higher the pH of the soil, and the more alkaline it is. The more Positive Hydrogen Ions in the soil, the lower the pH of the soil, and the more acidic it is.

Neutral/Balanced

pH = 7



In most cases, vineyards and orchards are needing to lower soil pH and become more acidic.

The most common way to lower pH has been to add Positive Hydrogen Ions to the soil by applying Sulfuric Acids or other acidic chemicals.

Acidic

pH is less than 7

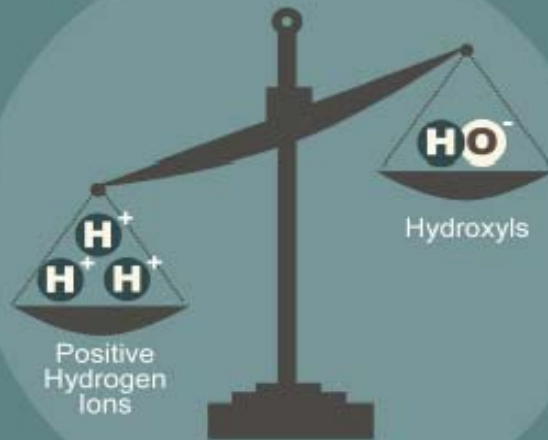

Alkaline

pH is greater 7

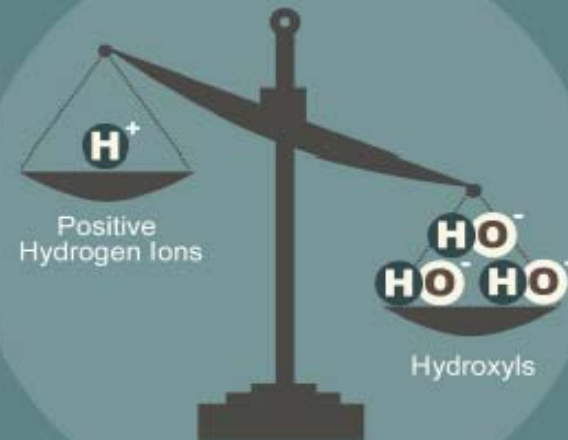

In Spray and Irrigation Water, what options do we have to deal with Hardness, Bicarbonates and Iron?

Water Treatment Units

Magnetic (HDMR) or electrical (in order of \$\$\$)

– Maximum H2O, Magnation, Pursanova, Talya, Water Changer

Sulfur Burners

Reverse Osmosis (RO)

Chemical/Acids

Low mineral levels – below 100ppm

- Citric Acid, Acetic Acid (vinegar), Phosphoric Acid

Moderate to Moderate/High levels – to 600ppm???

- Sulfuric Acid, Oxide (ChemFresh), Fulvic Acid

Other

Ammonium Sulfate (AMS) - binds Ca and Fe

Chemical Water Conditioners

Trickl-eez Irrigation - Chris Lattak
(chris@trickl-eez.com)

Hydrodynamic Magnetic Resonance (HDMR)

– Omni-Enviro Maximum H2O, Pursanova, Talya (electric unit)

pH – moderate balancing effect

Hardness - prevents/removes Ca, Mg and Fe deposits

Improves hydration, chemical/nutrient uptake

Cost – Moderate/High Initial; No On-going

Effectiveness – Moderate to Moderate/High ???



Water molecules
don't travel alone

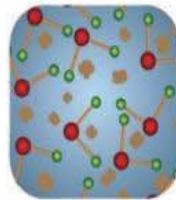

They bond together with
other water molecules...

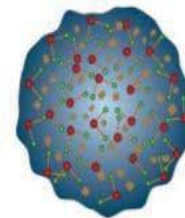

...to form water
molecule clusters.

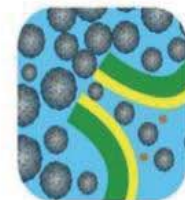

Many are too large
to enter the cell.



MAXIMUM H2O process

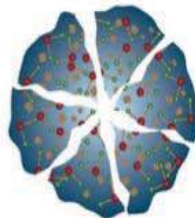

...breaks apart these
oversized clusters.

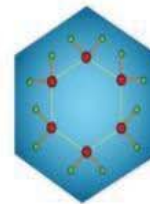

...into smaller, more
bioavailable sizes.

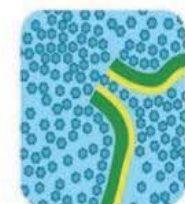

Resulting in full hydration

HARD WATER



TREATED WATER



MINERALS IN WATER AT 2000X MAGNIFICATION

Hard water Before and After passing through the Maximum H2O unit (similar results with other units).

Chemicals / Acids

Citric Acid, Acetic Acid (vinegar) Phosphoric Acid

pH – lowers pH

Hardness – treats up to 100pm (or so)

Helps prevent chemical/nutrient tie-up

Cost – Moderate Initial (Injector), Moderate To Moderate/High
On-going

Effectiveness – Moderate to Moderate/High up to 100ppm

Sulfur Burner**, Sulfuric Acid*, Oxide (Hypochlorous Acid), Fulvic Acid***

pH – lowers pH (not Oxide)

Hardness – treats up to 600+ppm ???

Helps prevent chemical/nutrient tie-up

Cost – Moderate (Injector); Moderate/High On-going

Effectiveness – Very

* Sulfuric Acid Breaks Down to Sulfate which is detrimental to soil biological health.

** Sulfur burners produce Sulfurous Acid and is beneficial to soil biological health.

*** Fulvic Acid has extremely positive effects on soil health

Sulfuric Acid's End Result

Sulfuric acid is a molecule made up of Oxygen, Sulfur, and Hydrogen atoms. In the soil, bacteria strip the molecule of its Hydrogen atoms lowering the soil's pH. Unfortunately the by-product left behind is a negatively charged sulfate salt that has many unintended negative effects on the plant and soil. If this salt builds up to a high concentration, plants become unhealthy and die.

Sulfuric Acid

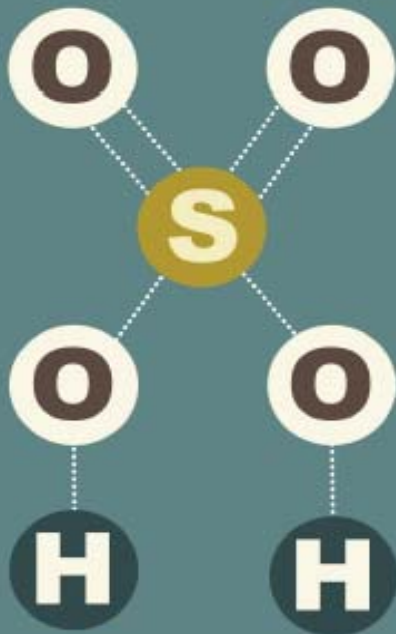

Conversion

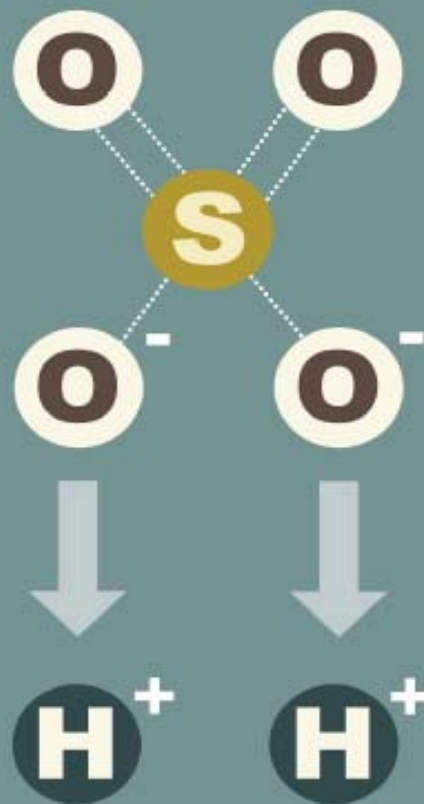

Sulfate



Other options that will help with hardness in spray water to some degree

AMS Equation March 8, 2013 www.btny.purdue.edu/weedscience

The following is an example water quality report and calculation of how much AMS needs to be added to the spray mixture using this equation.

The analysis results for the five elements from this report are:

Sodium (Na⁺): 15.7 mg/L

Potassium (K⁺): 1.03 mg/L

Calcium (Ca²⁺): 68.4 mg/L

Magnesium (Mg²⁺): 25.21 mg/L

Iron (Fe²⁺): 0.37 mg/L

** The values in this example are reported in mg/L, but these values could also be reported in ppm and the two would be identical in numerical value.*

The equation with input values would be:

$$\text{AMS (lbs/100gal)} = 0.005 * (\text{Na}^+) + 0.002 * (\text{K}^+) + 0.009 * (\text{Ca}^{2+}) + 0.014 * (\text{Mg}^{2+}) + 0.042 * (\text{Fe}^{2+})$$

Remember from 6th grade math to do the multiplication first, so multiply all values:

$$\text{AMS (lbs/100gal)} = 0.005 * (15.7) + 0.002 * (1.03) + 0.009 * (68.4) + 0.014 * (25.21) + 0.042 * (0.37)$$

Now do the addition and add all values to get the final answer:

$$\text{AMS (lbs/100gal)} = 0.0785 + 0.00206 + 0.6156 + 0.35294 + 0.01554$$

So the final answer is:

$$\text{AMS (lbs/100gal)} = 1.06464$$

From Spray Adjuvants for Fruit Crops – MI Fruit Management Guide 2015

- Buffer Xtra Strength – Helena
- Choice Weather Master – Loveland
- Weather Gard Complete – Loveland

From personal experience

- RidgeRunner – Reister
- Indicate 5 - Reister

Lattak

(chris@trickl-eez.com)

Reverse Osmosis (RO)

pH – balances to neutral - 7

Hardness – Vastly decreases

Vastly decreases

chemical/nutrient tie-up

Cost – High Initial; Low/Moderate

On-going

Effectiveness – Extremely

* Low volumes – max 7-12gpm

Greater volume is extremely expensive

Reductions of 50% and greater in
nutrient and pesticide usage, plus
improved crop performance.



Example of a small system Injection Station

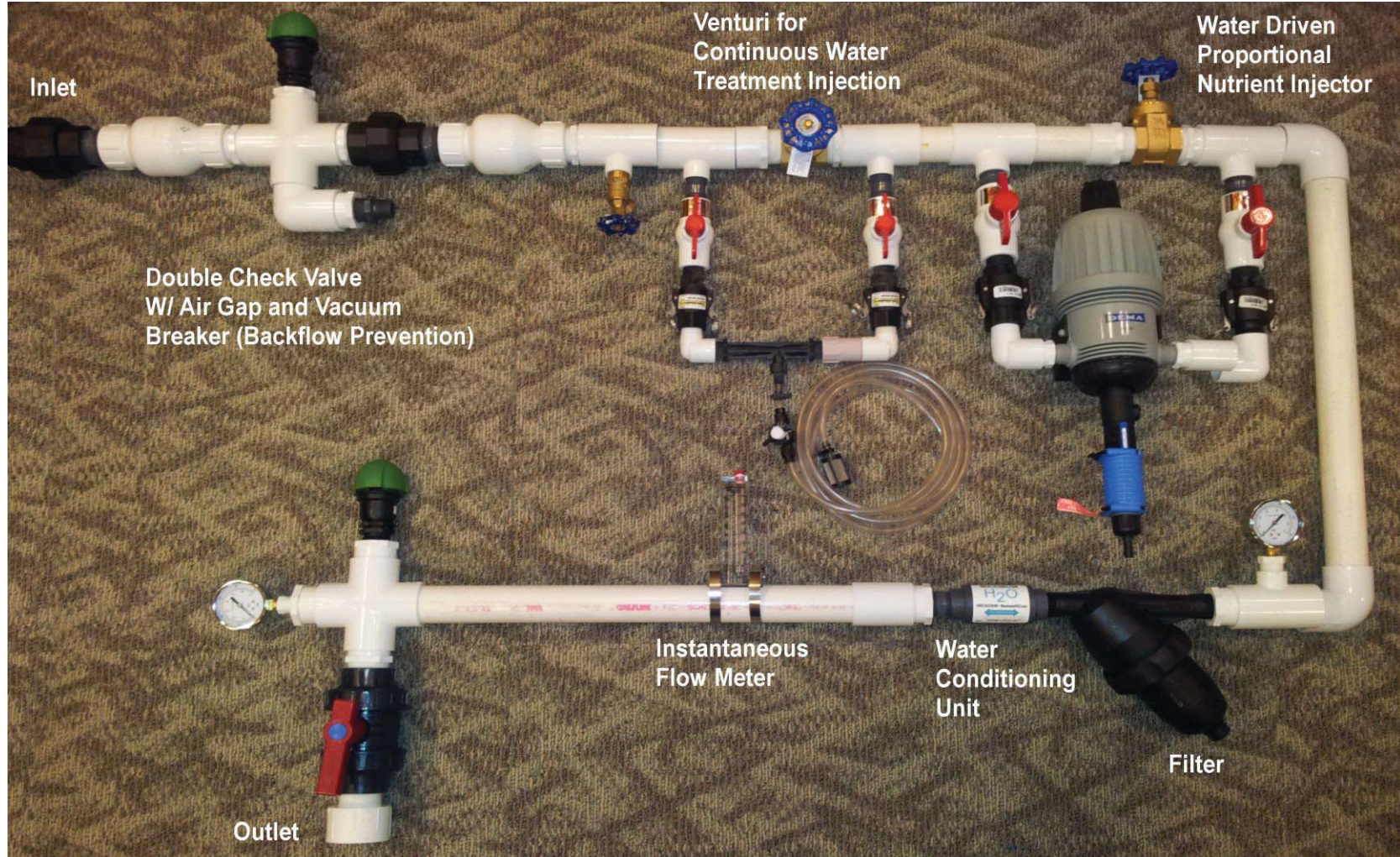

Trickl-eez Irrigation - Chris Lattak
(chris@trickl-eez.com)

Electrostatic Spraying

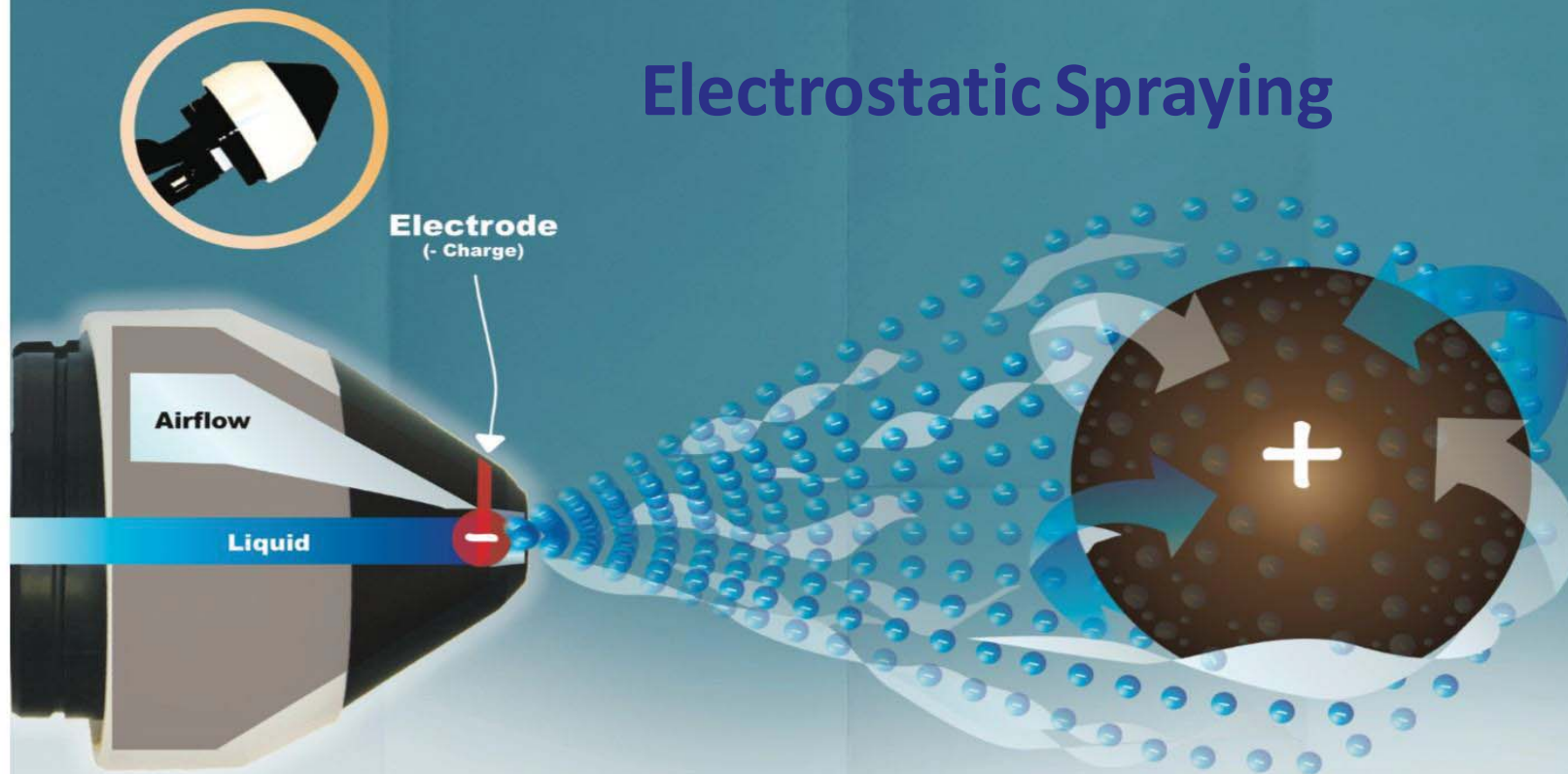

STEP 1: Separate liquid and air lines meet at the Maxcharge™ nozzle tip. The low pressure, high volume air flow quickly atomizes the liquid into uniform droplets. The small droplets then pass through an electromagnetic field. It is here that each droplet picks up a strong negative charge.

STEP 2: The turbulent air stream carries the maximally charged droplets quickly toward the spray target. Because each droplet carries the strong negative charge they spread out evenly to form a uniform spray cloud upon exiting the Maxcharge™ nozzle tip

STEP 3: Just like the pull of a magnet to a piece of metal the droplets become more strongly attracted to the target the closer they approach. In fact, the force of attraction is up to 75x that of gravity allowing for complete coverage of hidden surfaces.

Electrostatic sprayer benefits

- 15-40gpa w/superior coverage
 - ½ the tank fill time
- 45hp max
 - 2-3gph less diesel, smaller tractor
- Spray pollen
- Eliminate run-off
- Minimal drift
- Save on spray material
 - Decrease application rates

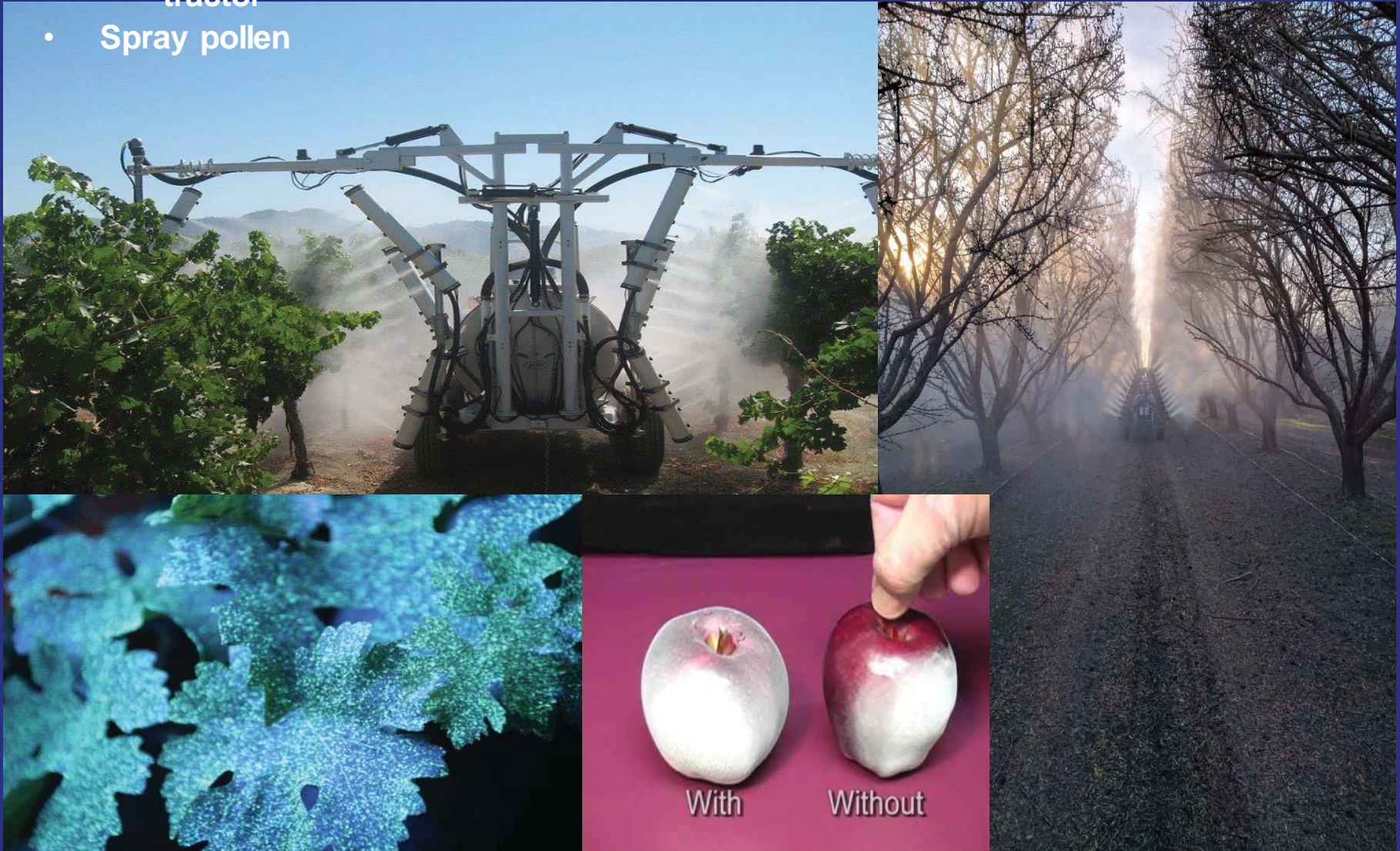

Variable Speed Control for the Main Irrigation Pump

(Variable Frequency Drive – VFD)



ADVANTAGES

- 1) Soft start to system: Water hammer mostly prevented
- 1) Less electricity used, so operating costs are lower
- 2) Can convert single phase power to 3-phase current to operate larger pumps (and lower operating costs)
- 3) The mainline of the irrigation system stays pressurized. Individual zones or sprayer fill locations can be manually operated without retuning to the pump controls
- 4) Rebates are sometimes available from the power company
- 5) Wider range of operating volumes, ie 250gpm maximum, then 40gpm minimum

Trickl-eez Irrigation - Chris Lattak
(chris@trickl-eez.com)

Variable Speed Control for the Main Irrigation Pump

(Variable Frequency Drive – VFD)

DISADVANTAGES

- 1) Initial Cost – several thousands of \$\$\$ extra
- 2) If a mainline break should occur and go undetected, the pump would come on and waste irrigation water, create a muddy mess until the break is discovered and repaired



Methods of Fertilizer Injection

1) Venturi Injectors

- a) Low cost
- b) No electricity needed
- c) Set up on a bypass system
- d) Creates 8-15psi of main line pressure loss while operating



2) Water Driven Injector Pumps

- a) Moderate Cost
- b) No electricity needed
- c) Proportional
- d) Non-proportional
- e) Can be portable with quick connects



Methods of Fertilizer Injection

3) Electric Injector Pump

- a) No loss of main line pressure
- b) Easily adjustable
- c) Dependable for automatic injection
- d) Can be ordered with acid head to do both fertilizer and/or acid
- e) Electricity required



Trickl-eez Irrigation - Chris Lattek
(chris@trickl-eez.com)

Backflow prevention – protecting our water supplies

- Basic check valve, no air gap – spring or flap
- Air gap, expensive (especially at the agricultural scale), significant pressure loss, problems with anything but “clean” water
- Chemigation Valve - Air Gap, cost effective

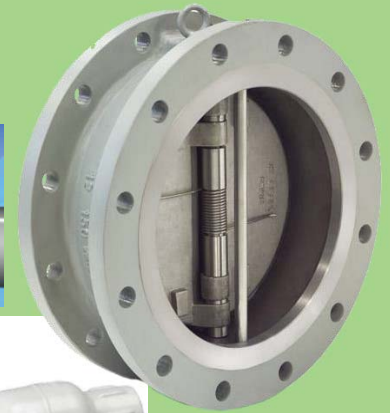
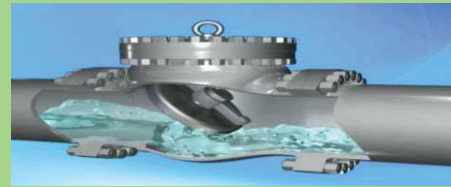

Pressure Regulators

- Prevents over pressurizing and damaging the vegetable tape (normal operating pressure depends on tape wall thickness, but is usually 8-12psi)
- Insures optimum water output
- Must be mounted in-line, usually at the zone valve
- Can be added to solenoid valve operation





Air Relief Valves



Are valves are very important components of a good irrigation system and are often overlooked

- a) Allows trapped air to escape, greatly preventing water hammer and resulting blow outs
- b) May be kinetic or continuous acting
- c) Must be located at high points of the piping system and at valves
- d) Allows air inlet when draining the irrigation system

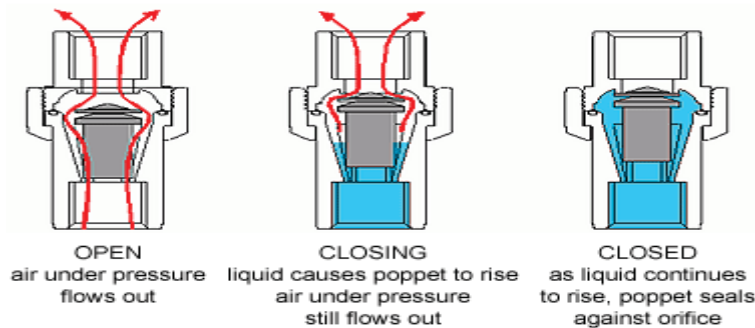

What are the best filter options for trickle irrigation where the water source is surface water?

- Sand Filters – provide the best filtration – use #16 sharp silica sand
- Disc Filter – 120, 140, or 200 mesh
- Screen Filter – 120 or 150 mesh

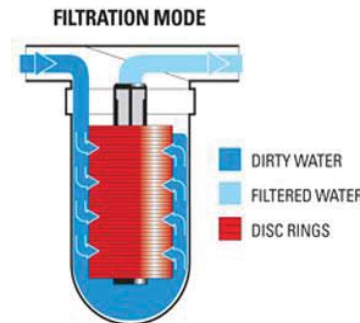

Should the filter backflush (clean) be manual or automatic?

er)

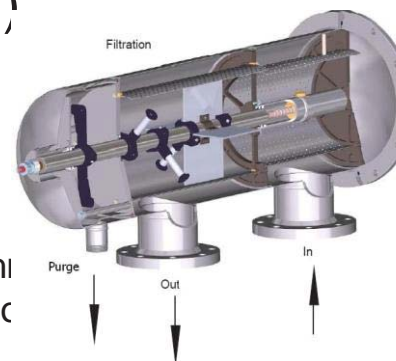

Flow Meters

- Being able to monitor water flow is very valuable
 - To check pump output & troubleshoot
 - Abnormal flow rates will indicate trouble
 - Ability to record (and report if necessary) overall water usage
- Several types of flow meters
 - Pilot tube (basic and instantaneous only)
 - Paddle wheel (digital)
 - In-line



is Lattak
om)

Pressure gauges – an inexpensive diagnostic tool

- 1) Air filled, or Liquid filled – Liquid are usually higher quality and longer lasting; helps even out vibrations from being located close to the pump
 - Install a pressure gauge on either side of the filter to monitor pressure loss through the filter
 - Install on every zone valve on outlet side (inlet side is also helpful)
 - May have to remove pressure gauges for the winter to keep from freezing

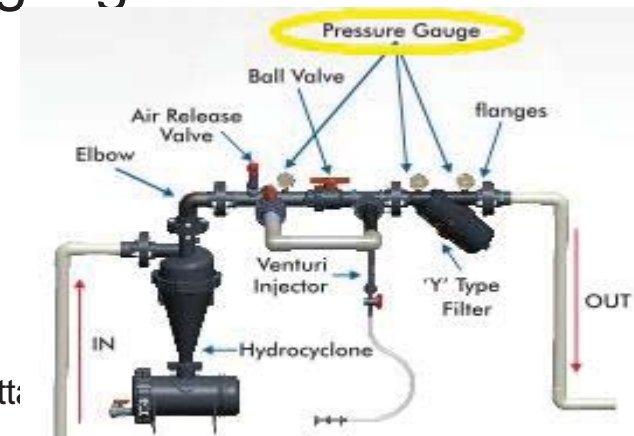

Trickl-eez Irrigation - Chris Latt:
(chris@trickl-eez.com)